

Voltage and Power Measurements

Fundamentals, Definitions, Products



ROHDE & SCHWARZ

60 Years of Competence in Voltage and Power Measurements

RF measurements go hand in hand with the name of Rohde & Schwarz. This company was one of the founders of this discipline in the thirties and has ever since been strongly influencing it. Voltmeters and power meters have been an integral part of the company's product line right from the very early days and are setting standards worldwide to this day.

Rohde & Schwarz produces voltmeters and power meters for all relevant frequency bands and power classes covering a wide range of applications. This brochure presents the current line of products and explains associated fundamentals and definitions.



WF 408022

Contents

RF Voltage and Power Measurements using Rohde & Schwarz Instruments	3
RF Millivoltmeters	6
Terminating Power Meters	7
Power Sensors for URV/NRV Family	8
Voltage Sensors for URV/NRV Family	9
Directional Power Meters	10
RMS/Peak Voltmeters	11
Application:	
PEP Measurement	12
Peak Power Sensors for Digital Mobile Radio	13
Fundamentals of RF Power Measurement	14
Definitions of Voltage and Power Measurements	34
References	38

RF Voltage and Power Measurements

The main quality characteristics of a voltmeter or power meter are high measurement accuracy and short measurement time. Both can be achieved through utmost care in the design of the probe or sensor and through the use of microprocessors for computed correction of frequency response, temperature effect and linearity errors.

Measurement accuracy

Two factors are decisive for the accuracy of power measurements: the precision of sensor calibration and the degree of sensor matching to the device under test. A great amount of hardware and software is involved especially in calibration. To ensure that the calibration standards for the URV/NRV sensors (see pages 8/9) comply with the stringent requirements, many of them are compared directly with the primary standards at the German Standards Laboratory (PTB).

Measurement errors due to mismatch are in practice the main source of error (see page 17 ff). Therefore the power sensors of the NRV-Z series are not only carefully calibrated but also optimized for minimum SWR.

Reliability

Even a top-quality measuring instrument may fail, either due to obvious functional faults or – with severe consequences – out-of-tolerance conditions that remain unnoticed. An increase in the measurement uncertainty is very difficult to detect in particular with power meters, since there are no reference instruments which are much more accurate and any com-

parison with another instrument is hampered by the effect of mismatch. Rohde & Schwarz resorts to a series of measures to ensure that the user can fully rely on the voltmeters and power meters supplied:

- Preaging of basic units and sensors in temperature tests lasting several days with monitoring of the drift and aging to identify unstable components
- High-quality RF connectors to ensure a constantly low SWR
- In-depth self-testing upon switch-on and during measurements

Operation

In many applications, operating the Rohde & Schwarz voltmeters and power meters just means connecting the DUT and selecting the display mode for the result. Fast autoranging and a digital averaging filter matched to the measurement range ensure optimally worked out results. Individual settings can be made either via the menu or by direct key entry. All information required on the instrument status (range hold, zero, etc) is displayed in plain text or using easy-to-understand symbols.

The displays with digital reading feature in addition a quasi-analog bargraph indicator with selectable scale to immediately show the user instantaneously the trend in signal variations. Level Meter URV 35 combines a pointer instrument with an LCD scale.

Individually calibrated and sensors

The sensors of the URV5/NRV-Z family permit direct measurement of voltages between 200 μ V and 1000 V and of powers between 100 pW and 30 W.

The frequency range extends from DC to 40 GHz. Several sensors with different frequency and power ratings are required to cover the entire measurement range. The Rohde & Schwarz sensors feature built-in calibration data memories and temperature sensors to ensure that the measuring instruments are calibrated and ready for use immediately after the sensor is plugged in. Manual calibration, a potential error source, is thus avoided.

The calibration-data memory contains all the relevant information required to produce accurate results, plus the sensor-specific data like serial number, type and calibration date as well as the permissible measurement and frequency ranges. It is merely the frequency of the current measurement that has to be entered on the meter which will then automatically scan the data memory for the relevant calibration factors and perform any required interpolation (see also page 21).

Each sensor can be used with any of the basic units of the URV/NRV series, ie voltage and power measurements are possible with one and the same instrument – with equally high accuracy.

Power Meters

Depending on the application, there are two types of power meters:

- Terminating power meters are connected to the output of a source, absorb the wave incident on the sensor and indicate the power of this wave.
- Directional power meters are connected between source and load and measure – practically with no loss – the power of the forward and reflected wave.

Terminating power meters

Depending on the principle of operation, the RF power is either converted into heat or measured with the aid of diode rectifiers.

The **thermal sensors** from R&S open up a wide power range from 1 μ W to 30 W. Irrespective of the waveform, they measure with extremely high accuracy the RMS value over the full range and are thus easy to use. Signals with harmonic contents or modulated and complex signals do not cause any additional measurement errors. Moreover, the R&S models feature an unrivalled linearity.

Diode sensors feature a higher sensitivity; their power measurement range starts at about 100 pW. Since they are able to measure true RMS power down to 10 μ W, they may even be used for signals with harmonic contents, noisy or modulated signals.

Diode sensors with an integral 20 dB attenuator fill the gap between pure diode sensors and thermal sensors. They provide true RMS measurements in a range up to 1 mW and satisfy the most exacting requirements on measurement speed even for levels between 10 and 100 μ W, where the use of thermal sensors is limited.

Peak power sensors contain a peak hold circuit for measuring the peak envelope power (PEP). They enable direct measurement of pulsed signals with a pulse width from 2 μ s, eg of the TV sync pulse peak power or the power of TDMA radio signals. In the range from 1 μ W to 20 W these sensors are a value-for-money alternative to special peak power meters.

Directional power meters

... are inserted into an RF line and measure the magnitude of the forward and reverse wave separately with the aid of a directional coupler. Directional Power Meters NRT and NAS can then be used to determine the transmitter output power and the antenna or load matching in all standard communication bands up to 4 GHz and for transmitter powers up to the kilowatt range. Due to the low insertion loss of the sensors, the power meter can remain connected to the transmitter for continuous monitoring. Special sensors with peak weighting are available for measuring pulsed signals such as in modern digital radio networks (see page 10).

NRT-Z43 and NRT-Z44 take a special place among the directional power sensors from Rohde & Schwarz. These sensors can be operated even without basic power meter on any PC under a Windows user interface. They can be connected via a standard serial (RS-232) or PC Card interface adapter.

Evolution in power measurements:
Directional Power Sensor NRT-Z44
as a self-contained measuring
instrument that can be connected
to every PC



WF 42665

Voltmeters

The sensors for the RF voltmeters from Rohde & Schwarz function similarly like diode power sensors. A diode rectifier in the sensors changes the unknown AC voltage into DC voltage. This DC voltage is processed in the basic unit (the rectifier characteristic being linearized by the microprocessor through correction) and indicated. Voltmeters operating on this principle use the square weighting of the diode rectifier to measure the RMS value of small voltages up to about 30 mV (or higher with divider) and the peak or – if a full-wave rectifier is used – the peak-to-peak value of voltages above 1 V. Due to linearization the meter reads the RMS value of a sinewave in the entire measurement range.

The **RF probe** is indispensable for measurements on non-coaxial circuits and components. Small input capacitance and low losses enable low-load measurements directly in the circuit. Dividers increase the voltage measurement range and minimize the loading of the DUT.

RF insertion units are used for voltage measurements in coaxial circuits. They incorporate a diode rectifier connected to the inner conductor or to a coaxial divider and permit broadband measurements to be made up to 3 GHz with low reflection coefficient. Given matched conditions, these insertion units can also be used for practically no-loss measurements of RF power. To avoid confusion with the insertion units of directional power meters, they are also referred to as coaxial voltage probes.

Which is the best?

Both methods – RF voltage and power measurement – have their merits and drawbacks. Users of Rohde & Schwarz Voltmeters URV 35 and URV 55 or Terminating Power Meters NRVS and NRVD however do not have to make a decision: as pointed out before, all voltage and power sensors of the URV5-Z and NRV series can be connected to any of the available meters with no loss in accuracy. This unique concept allows universal use of any model for the whole range of RF measurements.

WF 39821



Probes and insertion units being used in RF voltage measurements



WF 43230

RF Millivoltmeters



WF 43229

Level Meter URV 35

The name of the URV 35 already implies its dual use as a versatile voltmeter and power meter. It is suitable for mobile applications (battery-powered model), system-compatible via the RS-232-C interface and it features a unique combination of analog and digital display, the scale of the moving-coil meter being superimposed on an LCD display – with the appropriate indication range automatically selected, of course.

- DC to 40 GHz
- Voltages from μV to kV
- Powers from pW to kW
- AC-supply or battery powering
- Menu-guided operation
- Selectable scaling
- Frequency-response correction
- Attenuation correction
- Analog output
- Test generator 1 mW/50 MHz (optional)

RF Millivoltmeter URV 55

RF Millivoltmeter URV 55 fitted with IEC/IEEE bus is intended for use in labs or in test systems. All parameters like averaging filter, display resolution and measurement rate can be set manually with a minimum of effort. Fully automatic measurement is of course possible.

URV 55 features a wide range of sensors for all fields of RF voltage and power measurement and has a twin brother in power measurements, ie Power Meter NRVS.

- DC to 40 GHz
- Voltages from μV to kV
- Powers from pW to kW
- IEC/IEEE bus
- Frequency-response correction
- Attenuation correction
- Averaging filter, automatic/manual
- Analog output
- Test generator 1 mW/50 MHz (optional)

Terminating Power Meters



WF 43224

Power Meter NRVS

Power Meter NRVS – the twin brother of RF Millivoltmeter URV 55 – is the standard instrument for RF power measurements in laboratory and system applications.

- DC to 40 GHz
- Powers from pW to kW
- Voltages from μV to kV
- IEC/IEEE bus
- Frequency-response correction
- Attenuation correction
- Averaging filter, automatic/manual
- Analog output
- Test generator 1 mW/50 MHz (optional)

Dual-Channel Power Meter NRVD

NRVD is the high-end instrument among the Rohde & Schwarz power meters and voltmeters. Two fully independent channels, the simultaneously measured values of which can be referenced to each other, enable the NRVD to perform many relative measurements eg of attenuation and reflection (with the aid of a directional coupler or SWR bridge).

The IEC/IEEE-bus command set of the NRVD is in line with the SCPI standard. Additional inputs/outputs enhance the range of system applications.

A high-precision test generator is fitted as standard for checking the sensors as well as for measuring and adjusting add-on devices.

- DC to 40 GHz
- Powers from pW to kW
- Voltages from μV to kV
- Two independent channels
- IEC/IEEE bus to SCPI
- Frequency-response correction
- Attenuation correction
- Averaging filter, automatic/manual
- Test generator 1 mW/50 MHz fitted as standard
- Optional DC frequency input, analog outputs, trigger input and ready output

Power Sensors for the URV/NRV Family

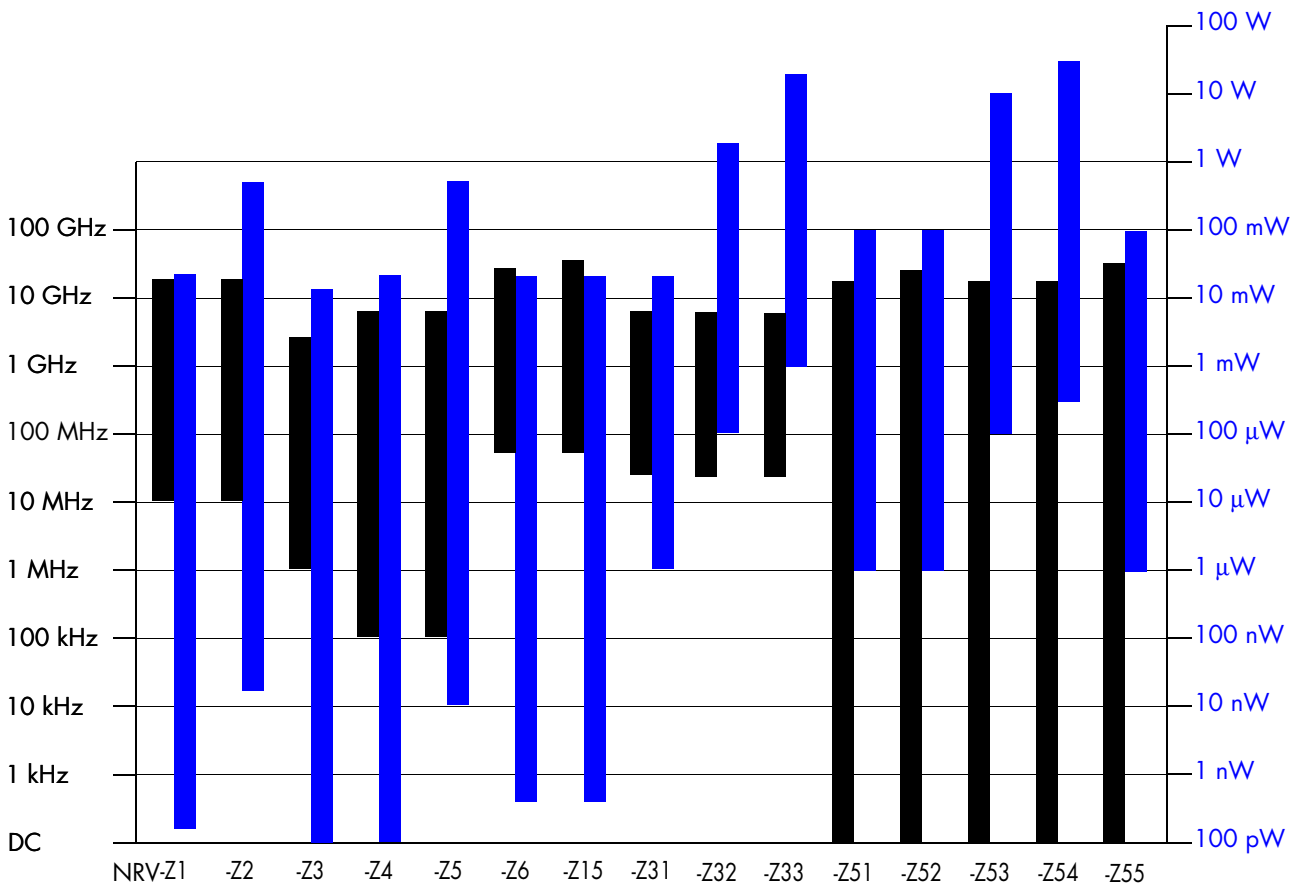

NRV-Z1	Diode Power Sensor 50 Ω 200 pW to 20 mW, 10 MHz to 18 GHz	Power measurements of highest sensitivity up to 18 GHz in 50 Ω systems
NRV-Z2	Diode Power Sensor 50 Ω 20 nW to 500 mW, 10 MHz to 18 GHz	Power measurements with minimum mismatch, for high powers in 50 Ω systems
NRV-Z3	Diode Power Sensor 75 Ω 100 pW to 13 mW, 1 MHz to 2.5 GHz	Power measurements in 75 Ω systems
NRV-Z4	Diode Power Sensor 50 Ω 100 pW to 20 mW, 100 kHz to 6 GHz	Power measurements of highest sensitivity and with extremely large dynamic range
NRV-Z5	Diode Power Sensor 50 Ω 10 nW to 500 mW, 100 kHz to 6 GHz	Same as NRV-Z4, but for higher powers and minimum mismatch
NRV-Z6	Diode Power Sensor 50 Ω 400 pW to 20 mW, 50 MHz to 26.5 GHz	Power measurements up to 26.5 GHz with high sensitivity and large dynamic range, PC 3.5 connector
NRV-Z15	Diode Power Sensor 50 Ω 400 pW to 20 mW, 50 MHz to 40 GHz	Power measurements up to 40 GHz with high sensitivity and large dynamic range, K connector
NRV-Z31	Peak Power Sensor 50 Ω 1 μW to 20 mW, 30 MHz to 6 GHz	Measurement of peak envelope power of modulated RF; three models, also for GSM (see page 13)
NRV-Z32	Peak Power Sensor 50 Ω 100 μW to 2 W, 30 MHz to 6 GHz	Same as NRV-Z31; two models, model 05 additionally for PDC and NADC (see page 13)
NRV-Z33	Peak Power Sensor 50 Ω 1 mW to 20 W, 30 MHz to 6 GHz	Same as NRV-Z31, but for direct power measurements on transmitters; two models (see page 13)
NRV-Z51	Thermal Power Sensor 50 Ω 1 μW to 100 mW, DC to 18 GHz	High-precision power measurement even of non-sinusoidal signals, N connector
NRV-Z52	Thermal Power Sensor 50 Ω 1 μW to 100 mW, DC to 26.5 GHz	Same as NRV-Z51, but with PC 3.5 connector for measurements up to 26.5 GHz
NRV-Z53	Thermal Power Sensor 50 Ω 100 μW to 10 W, DC to 18 GHz	High-precision measurement of high powers
NRV-Z54	Thermal Power Sensor 50 Ω 300 μW to 30 W, DC to 18 GHz	Same as NRV-Z53, but up to 30 W
NRV-Z55	Thermal Power Sensor 50 Ω 1 μW to 100 mW, DC to 40 GHz	Same as NRV-Z51, but with K connector for measurements up to 40 GHz



Voltage Sensors for the URV/NRV Family

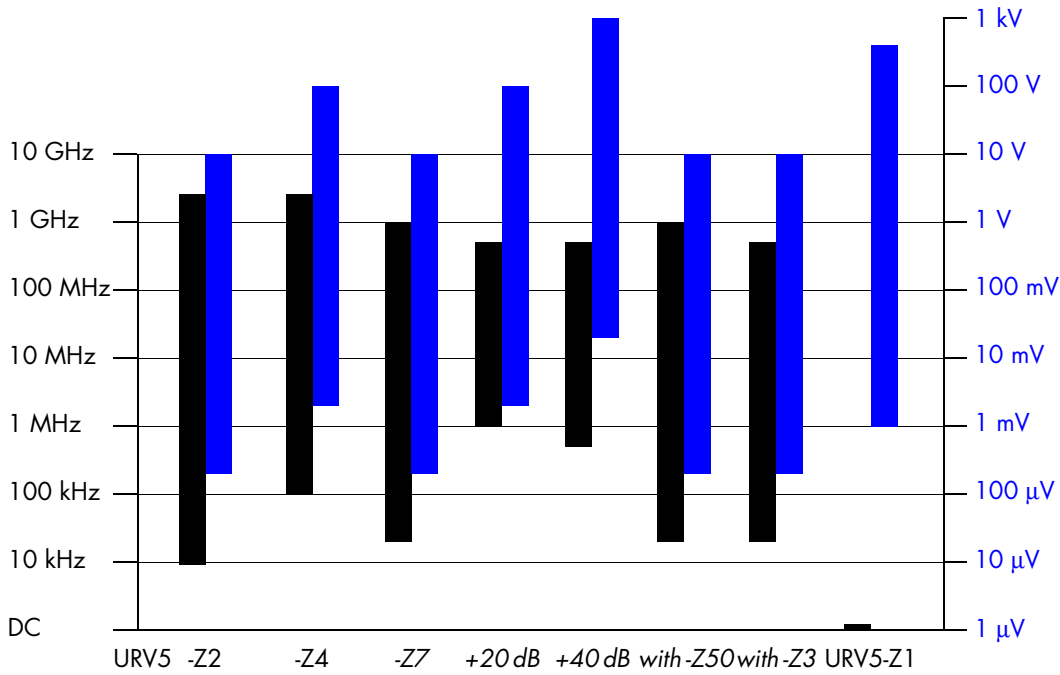

URV5-Z2	10 V Insertion Unit 50 Ω 200 μV to 10 V, 9 kHz to 3 GHz	Low-load RF voltage measurements and low-loss power measurements in well matched 50 Ω RF lines
URV5-Z4	100 V Insertion Unit 50 Ω 2 mV to 100 V, 100 kHz to 3 GHz	Virtually no-load RF voltage measurements on coaxial lines, even at high voltages. Due to minimum insertion loss and reflection coefficient, this unit leaves the RF line practically unaffected
URV5-Z7	RF Probe 200 μV to 10 V, 20 kHz to 1 GHz	For voltage measurements in non-coaxial RF circuits with low capacitive and resistive loading
...with 20 dB divider	2 mV to 100 V, 1 to 500 MHz	The 20 dB and 40 dB dividers enhance the measurement range of the RF probe; the high Q factor of the capacitive divider makes the resistive loading negligible and reduces the capacitive loading to 0.5 pF (40 dB divider)
...with 40 dB divider	20 mV to 1000 V, 500 kHz to 500 MHz	
...with 50 Ω Adapter URV-Z50	200 μV to 10 V, 20 kHz to 1 GHz	With built-in termination for power or level measurements up to 1 GHz on DUTs with 50 Ω source impedance
...with 75 Ω Adapter URV-Z3	200 μV to 10 V, 20 kHz to 500 MHz	With built-in termination for power or level measurements in 75 Ω systems such as antenna or video systems
URV5-Z1	DC Probe 1 mV to 400 V, 9 MΩ 3 pF	DC voltage measurements in RF circuits with minimum capacitive loading



WF 43230

Directional Power Meters



WF 43221

Directional Power Meter NAS

Directional Power Meter NAS is a favourably priced versatile instrument for use in the service and as a measurement device for the installation of mobile and stationary transmitter systems. Its main application is the measurement of transmit power and matching of digital mobile radio base stations and of mobile phones in vehicles.

- Insertion units for all areas of radiotelephony (including digital mobile radio)
- Simultaneous indication of forward power and SWR
- Battery operation

Power Reflection Meter NRT

Power Reflection Meter NRT is used for high-precision measurement of power and reflection. Its menu-guided operation is extremely user-friendly, with the main functions being selected at a key-stroke. For the first time a processor has been integrated in the sensor and a standard digital interface used between basic unit and sensor. This interface allows the sensor to be directly controlled from a PC. The large choice of sensors makes this instrument suitable for any applications in analog and digital radiocommunications.

- Simultaneous display of forward power and reflection
- Measurement of average power (AVG) irrespective of modulation mode
- Measurement of peak envelope power (PEP), crest factor and average burst power
- Compatible with all main digital standards, eg GSM, DECT, PHS, NADC, PDC, DAB, IS-95 CDMA, W-CDMA, etc
- NRT-Z sensors can be connected directly to a PC
- IEC/IEEE-bus and RS-232 interface
- Sensors of predecessor model NAP can be connected
- AC supply or battery operation (optional)

Sensors for NAS	NAS-Z1	NAS-Z2	NAS-Z3	NAS-Z5	NAS-Z6 for GSM 900	NAS-Z7 for GSM 900/1800/1900	Sensors for NRT	NRT-Z43 (can be connected to a PC)	NRT-Z44 (can be connected to a PC)
Meas. range	0.01 to 120 W	0.1 to 1200 W	0.01 to 120 W	0.01 to 120 W	0.01 to 120 W	0.01 to 30 W	Meas. range AVG PEP	0.007 to 30 W 0.1 to 75 W	0.03 to 120 W 0.4 to 300 W
Frequency range	1 to 30 MHz	1 to 30 MHz	25 to 200 MHz	70 to 1000 MHz	890 to 960 MHz	890 to 960 MHz 1710 to 1990 MHz	Frequency range	0.4 to 4 GHz	0.2 to 4 GHz

Sensors for NRT	NAP-Z3	NAP-Z4	NAP-Z5	NAP-Z6	NAP-Z7	NAP-Z8	NAP-Z9	NAP-Z10 (model 04 for GSM 900)	NAP-Z11
Meas. range AVG PEP	0.01 to 35 W —	0.03 to 110 W —	0.1 to 350 W —	0.3 to 1100 W —	0.05 to 200 W 0.5 to 200 W	0.5 to 2000 W 5 to 2000 W	0.3 mW to 1.1 W —	0.005 to 20 W 0.05 to 20 W	0.05 to 200 W 0.5 to 200 W
Frequency range	25 to 1000 MHz				0.4 to 80 MHz	0.2 to 80 MHz	0.1 to 1 GHz	35 MHz to 1 GHz (model 02) 890 to 960 MHz (model 04)	

RMS/Peak Voltmeters



WF 43226

These voltmeters feature a broadband amplifier which boosts the test signal virtually without any noise to the appropriate level for the built-in rectifiers. A high-impedance input circuit allows low-load measurements on the device under test. Commercial oscilloscope probes (1 : 1, 10 : 1, 100 : 1) may be connected for measurements in open circuits. The built-in amplifier has a bandwidth from DC to over 30 MHz. In contrast to customary thermal methods, an RMS-responding rectifier circuit patented by Rohde & Schwarz allows high measurement speed without any reduction in bandwidth and accuracy.

RMS Voltmeter URE 2

The URE 2 measures DC voltages and the RMS value of AC and AC+DC voltages. Measurement speeds of up to 30 measurements per second make the URE 2 an extremely efficient instrument in automatic test systems for use in production. Thanks to its high accuracy, great ease of operation and large variety of settings, it is the ideal instrument for the development lab.

- DC, 10 Hz to 25 MHz
- 50 μ V to 300 V RMS (AC, AC+DC)
- 20 μ V to 300 V DC
- IEC/IEEE bus

RMS/Peak Voltmeter URE 3

In addition to all the advantages of URE 2, the URE 3 features a frequency counter up to 30 MHz and a fast peak-responding rectifier. The frequency counter allows an automatic frequency-response correction. Digital signal processing extends the frequency range to the lower frequencies down to 0.02 Hz (RMS only). The measurement time can be exactly matched to the period of the test signal to achieve the shortest possible measurement time of one signal period.

- DC, 0.02 Hz to 30 MHz
- 50 μ V to 300 V RMS (AC, AC+DC)
- 100 μ V to 500 V \pm PEAK (AC, AC+DC)
- 20 μ V to 300 V DC
- Frequency measurement
- IEC/IEEE bus
- Analog outputs, TTL frequency input, trigger input, ready output (optional)

Application: PEP Measurement



WF 41894

Modern digital radio networks make high demands when it comes to power measurement. Rohde & Schwarz is taking account of this by continuously adding new sensors to its range of voltmeters and power meters. Each family of these instruments is fully GSM-compatible and provides measurement capabilities for many other digital communication standards.

Precision power measurements are indispensable in the development and production of radiotelephones as well as in the installation of complete transmitter systems.

For modulated or pulsed signals, measurement of the peak envelope power (PEP), the PEAK/AVG ratio

(crest factor CF), the complementary cumulative distribution function (CCDF) or the average power over a defined time interval is required to an increasing extent in addition to precise measurement of the simple average power (AVG) using thermal sensor or special diode sensors. Take for instance modern digital radio networks with TDMA structure. The information for the individual voice and data channels is compressed and sent in narrow timeslots. Several consecutive timeslots form a frame, and after this frame has been sent, the first timeslot is normally used again.

What one wants to measure is the power within the time slot and, possibly, the peak and average power. The

modulation mode determines whether the envelope within the timeslot is flat (eg with GMSK and GFSK) or whether it varies with the symbol rate as with $\pi/4$ DQPSK.

GSM specifications prescribe GMSK modulation. Eight timeslots of 577 μ s duration each form a 4.615 ms wide frame. Mobile stations occupy one time slot only and therefore send RF bursts of 577 μ s duration and a repetition rate of 216.7 Hz.

The specifications allow overshoots at the beginning of the transmission of up to 4 dB above the otherwise flat envelope of the burst. All sensors from Rohde & Schwarz with PEP function are able to measure the quasi-stationary power of a mobile station in the timeslot, ie its transmit power. With most sensors, overshoots are suppressed for measurement.

Depending on radio traffic density, GSM base stations occupy up to eight timeslots. Since, with a normal power meter, it is not possible to select a certain timeslot, the power of the timeslot in which the highest power is transmitted is usually indicated if sensors with PEP function are used.

TDMA radio sets using $\pi/4$ DQPSK modulation (eg to NADC, PDC or TETS standards) also send the information in the form of RF bursts, but the power transmitted within the burst varies with the symbol rate. The fluctuations about to about +2/-10 dB referred to the average value.

NRV-Z31 (model 02), NRV-Z32 (model 05) and Power Sensors NRT-Z43 and -Z44 determine the PEP of such signals.

Peak Power Sensors for Digital Mobile Radio

Type	Frequency range	Power range	Function	Burst width	Burst repetition rate	Uses
NRV-Z31 Model 02 Model 03 Model 04	30 MHz to 6 GHz 30 MHz to 6 GHz 30 MHz to 6 GHz	1 μ W to 20 mW 1 μ W to 20 mW 1 μ W to 20 mW	PEP PEP PEP	$\geq 2 \mu$ s $\geq 2 \mu$ s $\geq 200 \mu$ s	≥ 10 Hz ≥ 100 Hz ≥ 100 Hz	NADC, PDC, TFFS, INMARSAT M, TV, general NADC, PDC, TFFS, INMARSAT M, TV, general GSM 900/1800/1900, DECT
NRV-Z32 Model 04 Model 05	30 MHz to 6 GHz 30 MHz to 6 GHz	100 μ W to 2 W 100 μ W to 4 W	PEP PEP	$\geq 200 \mu$ s $\geq 2 \mu$ s	≥ 100 Hz ≥ 25 Hz	GSM 900/1800/1900, DECT, GSM 900/1800/1900, NADC, PDC
NRV-Z33 Model 03 Model 04	30 MHz to 6 GHz 30 MHz to 6 GHz	1 mW to 20 W 1 mW to 20 W	PEP PEP	$\geq 2 \mu$ s $\geq 200 \mu$ s	≥ 100 Hz ≥ 100 Hz	TV, general GSM 900/1800/1900
NAS-Z6	890 MHz to 960 MHz	0.01 W to 120 W	PEP	577 μ s	217 Hz	GSM 900/1800/1900
NAS-Z7	890 MHz to 960 MHz 1710 MHz to 1990 MHz	0.01 W to 30 W	PEP	577 μ s	217 Hz	GSM 900/1800/1900
NAP-Z10 Model 02 Model 04	35 MHz to 1000 MHz 890 MHz to 960 MHz	0.05 (0.005) W to 20 W 0.02 (0.005) W to 20 W	AVG, PEP AVG, PEP	$\geq 4.5 \mu$ s 577 μ s	≥ 50 Hz 217 Hz	TV, NADC, PDC, general GSM 900
NAP-Z11 Model 02 Model 04	35 MHz to 1000 MHz 890 MHz to 960 MHz	0.5 (0.05) W to 200 W 0.2 (0.05) W to 200 W	AVG, PEP AVG, PEP	$\geq 4.5 \mu$ s 577 μ s	≥ 50 Hz 217 Hz	TV, NADC, PDC, general GSM 900
NRT-Z43	400 MHz to 4 GHz	0.1 (0.007) W to 75 W	AVG, PEP, CF, BRST.AV, CCDF	$\geq 0.2 \mu$ s	≥ 10 Hz	GSM 900/1800/1900, NADC, PDC, DECT, TETRA, DAB, IS95-CDMA, W-CDMA
NRT-Z44	200 MHz to 4 GHz	0.4 (0.03) W to 300 W				

Power sensors compatible with digital mobile radio are available for all power meter families

Power Sensors NRT-Z43 and -Z44 additionally allow measurement of the average power within the active time-slot based on the duty cycle.

Measurement of the peak envelope power (PEP) and of the PEP/AVG ratio is particularly important for the IS-95

CDMA and W-CDMA communication standards. Due to the modulation method used very high signal peaks of 10 dB or more above the average power value may occur. Since signal distortion due to amplitude limiting may also cause crosstalk in adjacent channels, the linear response of all

components involved in signal generation is of great importance. The peak-to-average power ratio is an essential quality criterion of the transmitted signal. This parameter as well as the average power can easily and precisely be measured with the two Power Sensors NRT-Z43 and -Z44.

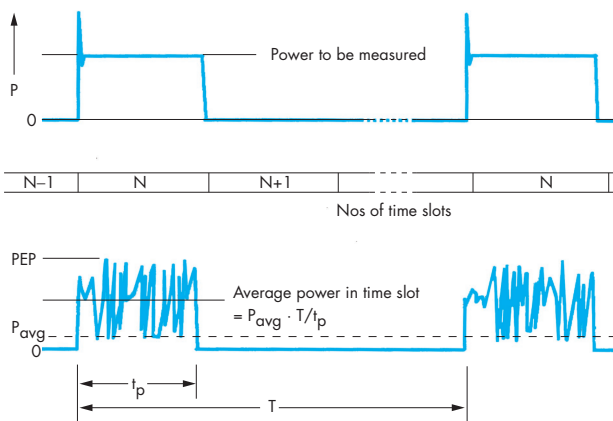

Envelope power of TDMA mobile station using GMSK or GFSK modulation (top) and $\pi/4$ DQPSK modulation (bottom)

Fundamentals of RF Power Measurement

The measurement of electrical power in RF and microwave applications has the same significance as voltage measurements in electronics or in electrical engineering. Power meters are used for a wide variety of tasks and are indispensable in the lab and test department. In comparison with spectrum or network analyzers, they are relatively unsophisticated instruments. However, the great progress that has been made in devising refined procedures for correcting probe errors over the last ten years is largely overlooked. In spite of this, the application of probes is limited on account of the inherent physical factors. Selecting an unsuitable probe is still the most frequent cause of errors in the measurement of RF power. This refresher topic will give an in-depth description of fundamental measurement principles which will help the reader select the most appropriate measurement equipment.

A second major source of error is the loading effect of the measuring equipment on the circuit under test. Effects of this kind can even occur at standard line interfaces where they mostly go undetected. When a power measurement is carried out correctly these errors become evident because the measurement errors themselves are considerably smaller.

1 Fundamentals

1.1 Power

The development of carrier-based telecommunications at the beginning of this century saw a parallel development in the field of RF voltage, current and power measurements. The majority of methods were based on converting electrical energy into heat. For a long time, this was the only way of making accurate measurements at practically any frequency. In the meantime, direct voltage and current measurements can be made up into the GHz range without having to convert electrical energy into heat. Nevertheless, the intensity of RF and microwave signals is still given in terms of power. Apart from the high accuracy of thermal power meters, there are other important reasons for using power.

Any signal transmission by waves, for example sound propagation, involves

the transfer of energy. Only the rate of energy flow, power, is an absolute measure of wave intensity. In the RF and microwave ranges, the wave properties of the electromagnetic field play an important role because the dimensions of the lines and subassemblies used are of the same order of magnitude as the wavelength used. This fact has to be taken into account when the quantity to be measured is selected. Voltage and current are less appropriate because they depend on the physical characteristics of the transmission medium (dimensions, dielectric constant, permeability) and field strength. Consider, for example, two matched coaxial cables with characteristic impedances of $50\ \Omega$ and $75\ \Omega$. For the same transmitted power, the voltage and current for the two impedances differ by a factor of 1.22.

There are further reasons for selecting power as the quantity to be measured. There is no direct way of measuring voltage and current in waveguides,

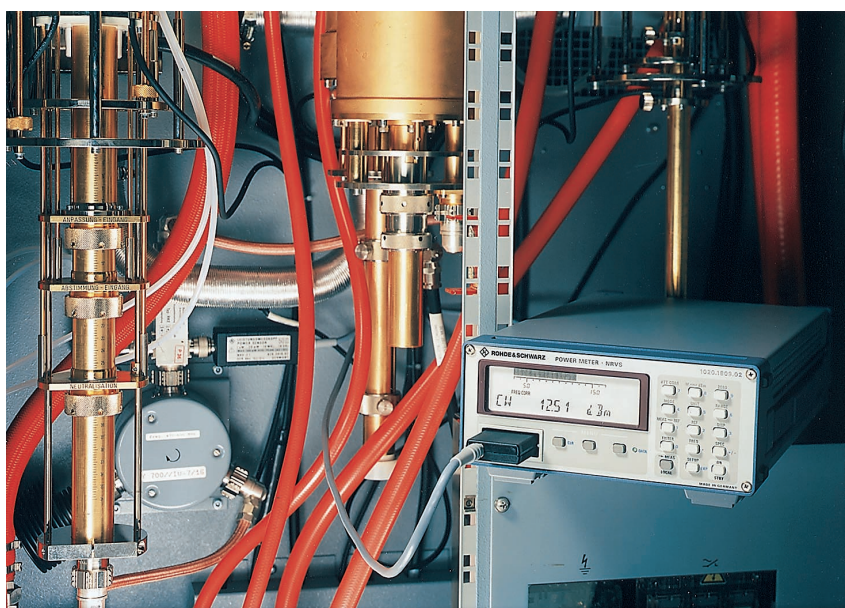

Fig. 1:
Power measurement on TV transmitter
using Power Meter NRVS

WF 40103

Definition of Power

and when standing waves occur, there are large measurement errors. And of course power handling capacity is a crucial factor that determines system or equipment design. All the components in a power transmitter or amplifier, from the AC line connector, through cooling system to the coaxial RF output, depend on the magnitude of the RF power.

The commercial aspects of measuring very high powers, say in a TV transmitter (Fig. 1), are also worth mentioning. Every percent of measurement error represents a relatively large power which has to be paid for. A manufacturer of a transmitter with a specified power of 10 kW may have to build in an extra 100 W of RF power for every 1% measurement error to cover himself on acceptance.

1.2 Definition of Electrical Power

Power is usually defined as the rate of transfer or absorption of energy in a system per unit time. The power transmitted across an interface is then the product of the instantaneous values of current and voltage at that interface (Fig. 2):

$$p(t) = v(t) \cdot i(t) \quad (1)$$

In the case of the sinusoidal signals encountered in RF and microwave engineering, the instantaneous power $p(t)$ oscillates about the average power at a frequency that is twice that of the original waveform. Only the

average power can be measured in practice and is referred to as power P . P is related to the RMS voltage V , the RMS current I and the phase ϕ by the following equation

$$P = V \cdot I \cdot \cos \phi \quad (2)$$

To avoid confusion with other power definitions, P is referred to as the true or active power.

When modulated sinusoidal signals are considered, other definitions of power are more appropriate (Fig. 3).

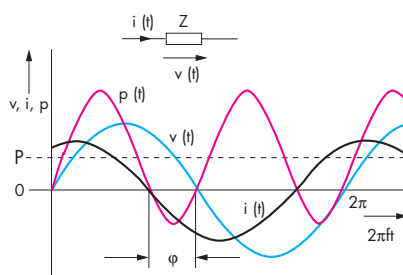

Fig. 2: Power absorbed by passive two-port with a sinusoidal signal applied (v , i , p = instantaneous values of voltage, current and power, P = average power)

The average of P over the modulation period is called the average power P_{avg} . This is what would be indicated by a thermal power meter.

The power averaged over the period of a carrier is referred to as the envelope power $P_e(t)$. It varies in time with the modulation frequency. The maximum envelope power is referred to as the peak envelope power or PEP. PEP is an important parameter for specifying transmitters. PEP and the envelope power can only be measured with

peak or envelope power meters which use fast diode sensors.

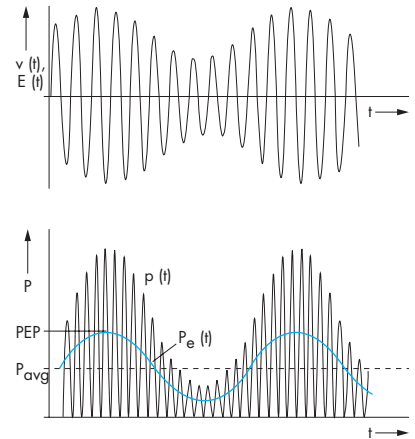

Fig. 3: Envelope of a modulated microwave signal top: voltage/field strength bottom: instantaneous power $p(t)$, envelope power $P_e(t)$, peak envelope power PEP and average power P_{avg}

A different approach may be used for RF bursts. If the duty factor t_p/T is known, the peak power can be calculated from the average power P_{avg} (Fig. 4). To distinguish it from the peak envelope power it is also referred to as the pulse power P_p .

$$P_p = \frac{P_{avg}}{(t_p/T)} \quad (3)$$

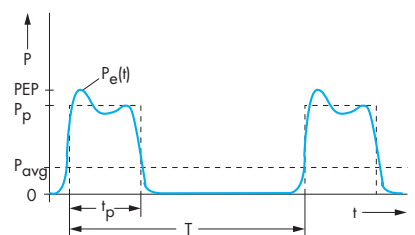

Fig. 4: Pulse power P_p (dashed line)

Power Transmission

1.3 Units and Power Level

Electrical power is measured in watts (W). Because of the large power ranges that have to be measured, values are usually expressed as the log of a power ratio. A relative power level L_r is expressed in terms of the log of the ratio of a power P to an arbitrary reference power P_0 ; the units are dB:

$$L_r = 10 \log_{10} \left(\frac{P}{P_0} \right) \text{ dB} \quad (4)$$

Absolute power level L_{abs} is referred to 1 mW and measured in dBm:

$$L_{\text{abs}} = 10 \log_{10} \left(\frac{P}{1 \text{ mW}} \right) \text{ dBm} \quad (5)$$

$$P = 1 \cdot 10^{L_{\text{abs}}/10} \text{ dBm} \text{ mW} \quad (6)$$

A list of corresponding absolute and relative power levels is given below with a range of values of 10^{18} :

Power P	Level $L_{\text{abs}}/\text{dBm}$
1 pW	-90
1 nW	-60
1 μ W	-30
1 mW	0
1 W	+30
1 kW	+60
1 MW	+90

2 Power Transmission and Matching

The electromagnetic wave is an extremely useful concept for describing the transmission of energy in the

RF and microwave ranges. The whole complexity of matching can thus be made very transparent without too many theoretical considerations. Therefore the main parameters and their relations are to be explained on this basis. Expressions in terms of voltage and current in coaxial systems will be presented at the end of the chapter.

2.1 Source and Load

Any kind of RF power measurement takes place between a source and a load. In a terminating power measurement, the measuring instrument itself is the load. In contrast to high-impedance, virtually no-load voltage measurements, the effects of the load on the source usually cannot be neglected and are therefore to be examined in more detail.

Let us assume that source and load are connected to a standard transmission line, for example a piece of coaxial line with the characteristic impedance Z_0 (Fig. 5). The source is to supply a sinusoidal signal of constant amplitude. The line is assumed to be free of losses. As the transients die away, there will be two stationary waves formed,

one flowing from the source to the load and the other one in reverse direction from the load to the source. The two waves carry the incident power P_i and the reflected power P_r , which is usually smaller. The ratio P_r/P_i only depends on the matching of the load to the line and is zero in the case of ideal matching.

$$\frac{P_r}{P_i} = r_L^2 \quad (7)$$

r_L is the magnitude of the reflection coefficient of the load. For the majority of power measurements it is sufficient to consider the magnitude. Otherwise the phase angle Φ_L has to be specified as well. Magnitude r_L and phase Φ_L can be combined in a complex quantity, the complex reflection coefficient Γ_L :

$$r_L = |\Gamma_L|, \quad \Phi_L = \arg(\Gamma_L)$$

The log of the power ratio $10 \log_{10} P_i/P_r$ (in dB) is referred to as the return loss a_r and, like the reflection coefficient r and the SWR, used as a measure for matching (Fig. 6).

The net difference between incident and reflected power is dissipated by the load; it is usually referred to as net power or absorbed power P_d :

$$P_d = P_i - P_r \quad (8)$$

$$P_d = P_i(1 - r_L^2) \quad (9)$$

The log of the power ratio $10 \log_{10} P_i/P_d$ (in dB) is referred to as mismatch loss a_d . It expresses the relative power loss caused by reflection. For reflection

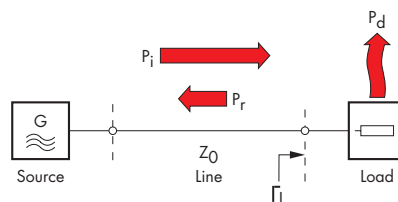

Fig. 5: Power flow between source and load

Nominal Power

coefficients smaller than 0.1 (10%) the power loss is smaller than 1%, meaning that incident power and absorbed power are more or less equal.

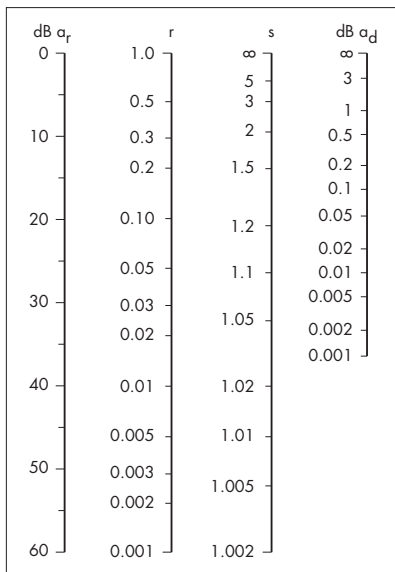

Fig. 6 Nomogram for reflection coefficient r , SWR, return loss α_r , and mismatch loss α_d

2.2 Available Source Power

So far, power ratios as a function of load mismatch have been considered only. Absolute power levels on the other hand strongly depend on the nominal power of the source. There are two definitions:

Theoretically, the maximum available net power P_{Gmax} is defined as the nominal power of the source. To absorb this power, conjugate matching of the load to the source is required. This means that the magnitudes of the reflection coefficients must be equal

while the phases are in opposition: $r_L = r_G$, $\Phi_L = -\Phi_G$ (index G referring to source of generator). Since the maximum available power is independent of the line used, it can be measured with high accuracy. The conjugate matching via a tuner (Fig. 7) is however time-consuming and not acceptable for many sources, for instance power output stages with low output impedance.

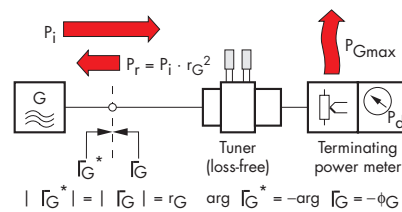

Fig. 7: Measurement of maximum available source power with conjugate matching via tuner

A more practical definition of nominal source power is the power that can be absorbed with the output being terminated with the specified characteristic impedance. It is also referred to as the power P_{GZ0} delivered to Z_0 load. This is the definition commonly used in RF and microwave measurements. To measure this power, a calibrated terminating power meter must be connected to the source (Fig. 8). The accuracy that can be attained is somewhat limited by the mismatch uncertainty (see further below).

The maximum available power and the power at Z_0 are related to each other by the reflection coefficient of the source (r_G):

$$P_{Gmax} = \frac{P_{GZ0}}{1 - r_G^2} \quad (10)$$

The two powers are equal only in the case of matched source ($r_G = 0$), otherwise P_{Gmax} is always greater than P_{GZ0} .

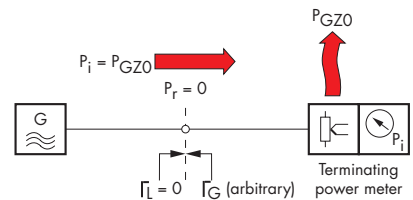

Fig. 8: Measurement of source power delivered to Z_0 load

2.3 Power with Mismatched Load

With a matched source (Fig. 9a) the absorbed power decreases with increasing magnitude of the reflection coefficient r_L irrespective of the phase:

$$P_d = P_{GZ0}(1 - r_L^2) \quad \text{for } r_G = 0 \quad (11)$$

The power reduction is solely attributable to the reflection losses at the load. The incident power remains unchanged, as shown by a comparison with equation (9).

$$P_i = P_{GZ0} \quad \text{for } r_G = 0 \quad (12)$$

With a mismatched source, the incident power is always equal to the power delivered to Z_0 load. Load mismatch has no effect.

With a mismatched source (Figs. 9b/c), the absorbed power is dependent on the magnitude and phase of the two reflection coefficients r_L and r_G . If, for instance, the magnitude of the reflec-

Mismatch

tion coefficient of the load is kept constant while only its phase is varied, the power varies periodically about an average value. If the reflection coefficients are small, this average value is equal to the power delivered to Z_0 load. With matching degrading, the average value decreases due to the losses caused by reflection and the span of variation increases.

The effect of the load can be explained by the fact that the reflected wave is reflected again by the mismatched source (secondary reflection) and superimposed on the forward wave. Depending on the phase, there is either a gain or a loss. With a matched source, the reflected wave however is fully absorbed, so that the incident power remains constant.

The power levels can only be calculated if magnitude and phase of the reflection coefficient of the source and load at the reference plain are known. The incident power can then be calculated as follows:

$$P_i = \frac{P_{GZ0}}{|1 - \Gamma_G \cdot \Gamma_L|^2} \quad (13)$$

Absorbed and reflected power can then be derived using equations (7) and (9). With source or load matching, the special case $P_i = P_{GZ0}$ applies.

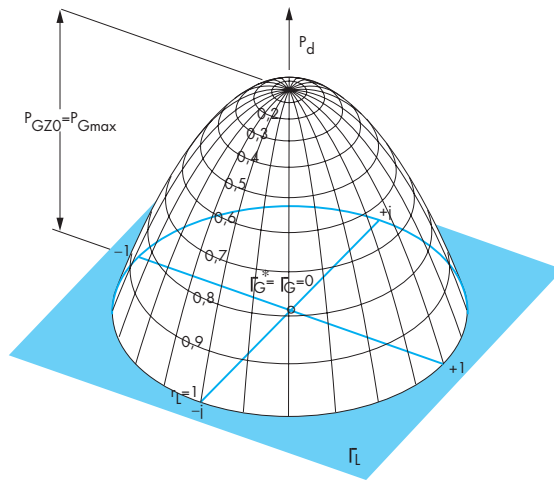
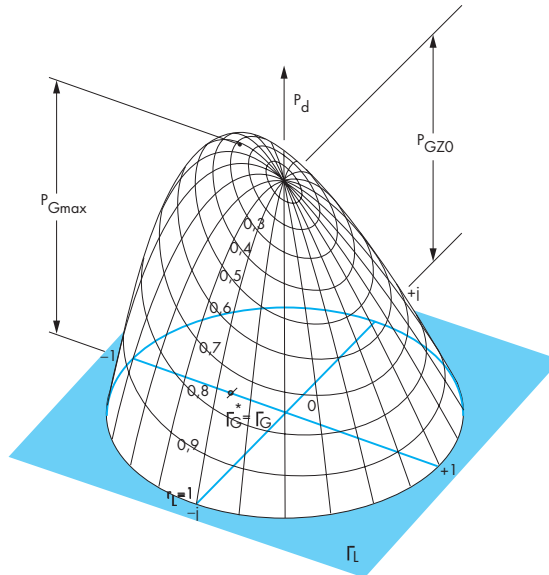
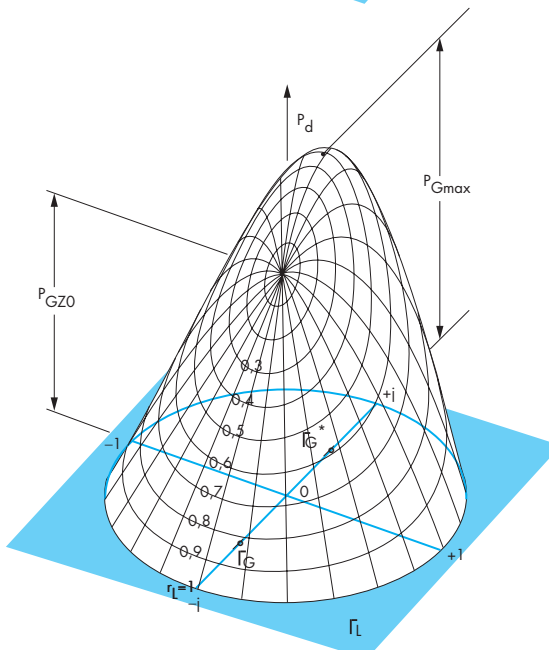

Fig. 9: Net power of a source, plotted versus the plane of the complex load reflection coefficient Γ_L . The grid lines of the 3-D surface are obtained by projection of the circles $r_\Gamma = \text{const.}$ and the straight lines $\Phi_\Gamma = \text{const.}$

a) matched source ($r_G = 0$)



b) mismatched source,
 $r_G = 0.3$
(SWR = 2; $\Phi_G = 180^\circ$)



c) mismatched source,
 $r_G = 0.5$
(SWR = 3; $\Phi_G = -90^\circ$)

Voltage and Current

2.4 Mismatch Uncertainty

In practice, the phase angle of the reflection coefficients of the source and load is not useful to consider, particularly since it changes with any alteration of the line length, as for instance by means of an adapter. It is thus only possible to determine the spread of the transmitted power. The incident power can be determined from the following relationship:

$$\frac{P_{GZ0}}{(1+r_G r_L)^2} \leq P_i \leq \frac{P_{GZ0}}{(1-r_G r_L)^2} \quad (14)$$

This relationship expresses a measure of uncertainty for the power determination. It implies that a terminating power meter cannot accurately measure the power of a mismatched source delivered to Z_0 load unless it is ideally matched itself.

The maximum relative error ϵ_m between P_i and P_{GZ0} is determined by way of approximation (Fig. 10):

$$\epsilon_m \% \approx 200 \% r_G \cdot r_L \quad (15)$$

$$\epsilon_{m\text{ dB}} \approx 8.7 \text{ dB } r_G \cdot r_L \quad (16)$$

The approximation is sufficiently accurate for $\epsilon_m \% < 20\%$ and $\epsilon_{m\text{ dB}} < 1 \text{ dB}$.

Example: A terminating power meter measures an incident power $P_i = 10.0 \text{ mW}$. With $r_G = 0.22$ and $r_L = 0.10$, the maximum measurement error may amount to $\pm 4.4\%$ (0.19 dB). The source power delivered to Z_0 is then in a range between 9.56 mW and 10.44 mW.

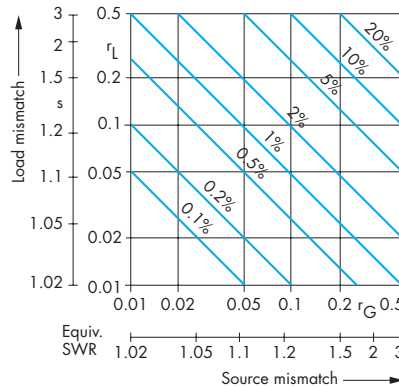

Fig. 10: Maximum measurement error due to mismatch

2.5 Voltage, Current and Power

In coaxial systems, voltage and current may be used for measuring the power. With matching ($r_L = 0$), these two parameters remain constant all along the line and are related with each other via the (real) characteristic impedance Z_0 :

$$V = I \cdot Z_0 \quad \text{for } r_L = 0 \quad (17)$$

The absorbed power can be calculated from the RMS values:

$$P_d = P_i = \frac{V^2}{Z_0} = I^2 Z_0 \quad (18)$$

for $r_L = 0$

With a mismatched load, the value of voltage and current depends on where the measurement is made along the line (Fig. 11) and is shifted in phase with respect to each other. If the transmitted power is to be accurately determined, the two parameters must be measured

at the same place. Moreover, the phase shift φ has to be considered. Irrespective of the place of measurement,

$$V \cdot I \cdot \cos \varphi = P_d \quad (19)$$

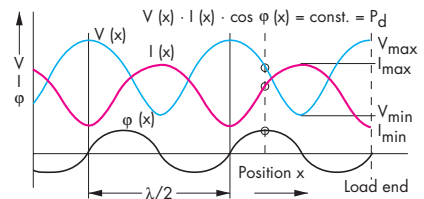

Fig. 11: Voltage and current on a line with mismatched load ($r_L = 0.5$; $\Phi_L = 0^\circ$); λ = line wavelength, φ = phase shift between V and I

In the microwave range neither current nor phase shift can be accurately measured, whereas the voltage can be determined with high accuracy using coaxial voltage probes. With a matched load or less demanding requirements on measurement accuracy, the power can be calculated from equation (18). To estimate the error in the case of mismatch, V^2/Z_0 was plotted versus the line length in Fig. 12, in other words the power that would be expected in case of matching. A sineshaped curve is obtained, the average value of which is approximately equal to the incident power P_i .

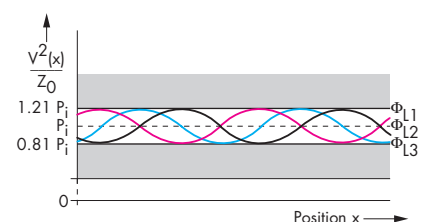

Fig. 12: Power indicated when measured with a voltage probe ($r_L = 0.1$; at different values of Φ_L)

Power Meters

Maxima and minima are obtained at $P_i (1 \pm r_L)^2$. Fig. 13 shows the measurement error to be expected for the incident power.

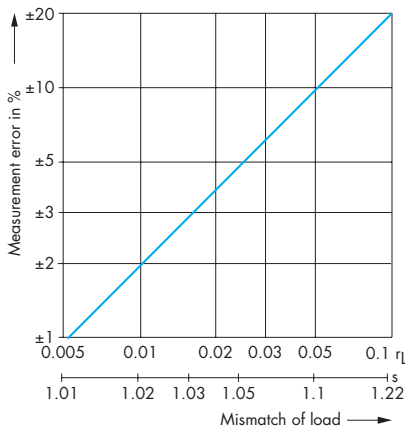

Fig. 13: Maximum measurement error for the incident power measured with a voltage probe

2.6 Standing Wave Ratio

The interference pattern obtained through the combination of forward and reflected wave is referred to as standing wave. It is periodical at half a line wavelength. Maxima and minima are obtained at the points where voltage and current of the two waves are of equal or of opposite phase. Their distance from the line end is determined by the phase angle Φ_L .

The ratio of the maximum to the minimum values is a measure of the magnitude of the reflection coefficient at the load. It is referred to as standing wave ratio SWR and can be determined to very high accuracy on transmission lines. Considering that voltage and current of forward and reflected wave are in a ratio of $1 : r_L$, the SWR

can be easily derived as a function of load reflection coefficient:

$$SWR = \frac{V_{max}}{V_{min}} = \frac{I_{max}}{I_{min}} = \frac{1 + r_L}{1 - r_L} \quad (20)$$

With matching, $SWR = 1$; with total reflection, $SWR = \infty$.

The terms standing wave ratio (SWR) and voltage standing wave ratio (VSWR) are both used for the above ratio. They have found wide acceptance to the extent that they are even used to describe source matching. It should however be borne in mind that substituting r_L for r_G in equation (20) is merely a definition and does not reflect the real SWR of the line.

3 Power Meters

RF power meters have to satisfy a large variety of requirements. In addition to a wide frequency and power range, low measurement uncertainty is above all a desired factor. With the introduction of digital radio networks there is an increasing demand for measurements of modulated signals, from the simple determination of the peak value through to detailed analysis of the envelope. Moreover, monitoring of the incident and reflected power should be possible as well as determination of the power available from any kind of sources. Different types of power meters are available to cover all these requirements.

Terminating or absorption power meters are versatile instruments allow-

ing measurements of high accuracy in particular in conjunction with thermal sensors. The Rohde & Schwarz Power Meters NRVS and NRVD (see page 7) are typical examples. Connected to the output of a source, they measure the available power (Figs. 7 and 8). In conjunction with directional couplers, power splitters and SWR bridges they are also suitable for directional power measurements, attenuation and SWR measurements and they can be used as calibration standards. Usually, the power absorbed in the termination is measured with the aid of a thermocouple or diode sensor. In this way, the average power and, using appropriate diode sensors, the peak power can be measured.

Peak power or envelope analyzers with power sensors based on fast diode sensors enable measurement of the envelope power. They are ideal for in-depth analysis of modulated signals as can be found with radar equipment, nuclear spin tomographs, TDMA radio equipment etc. Comparable with a digital oscilloscope, they are able to detect single and periodical changes of the envelope power. They feature a large variety of trigger facilities, screen display of the results, cursor readouts and the like (Fig. 14).

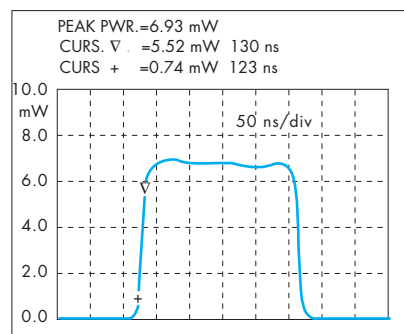

Fig. 14: Screen display of envelope power

Sensors



WF 40541

Fig. 15: Directional Power Meter NAS used for measuring the power and SWR of a GSM mobile phone

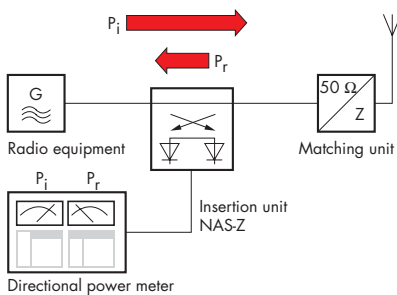

Fig. 16: Block diagram of directional power measurement as shown in Fig. 15

Directional power meters or feed-through power meters are available for in-service measurements on antennas, radio equipment or other high-power RF generators (Figs. 15 and 16). The built-in dual directional coupler (reflectometer) enables monitoring of incident and reflected power and hence SWR measurements under operating conditions. The difference between incident and reflected power is always equal to the power

absorbed by the load. Unlike the incident and reflected power, it is not dependent on the characteristic impedance of the directional power meter and is therefore even correctly measured when the characteristic impedance of the test setup is different from that of the power meter or there is no defined reference at all.

3.1 RF Interface

Except for a few handheld units, the RF signal is processed in a detached sensor. For automatic correction of systematic measurement errors (linearity, frequency response, temperature effect) modern sensors contain a digital memory with the sensor-specific data and a temperature sensor for correction of the temperature-dependent

parameters (Fig. 17). A large variety of sensors is available to suit a wide frequency and power range. Terminating sensors can be used to cover the entire microwave range up to 330 GHz. The sensitivity is determined to a large extent by the measurement principle. Thermocouple sensors can be used from about 1 μW, diode sensors from 100 pW. The upper measurement limit can be extended into the kW or MW range by connecting attenuators or directional couplers.

Power meters are as a rule hooked up to defined interfaces. These are standardized transmission lines, either coaxial lines with a characteristic impedance of 50 Ω (75 Ω) or waveguides of various types. The frequency ranges listed in the table below are typical for power sensors. Due to their small band-

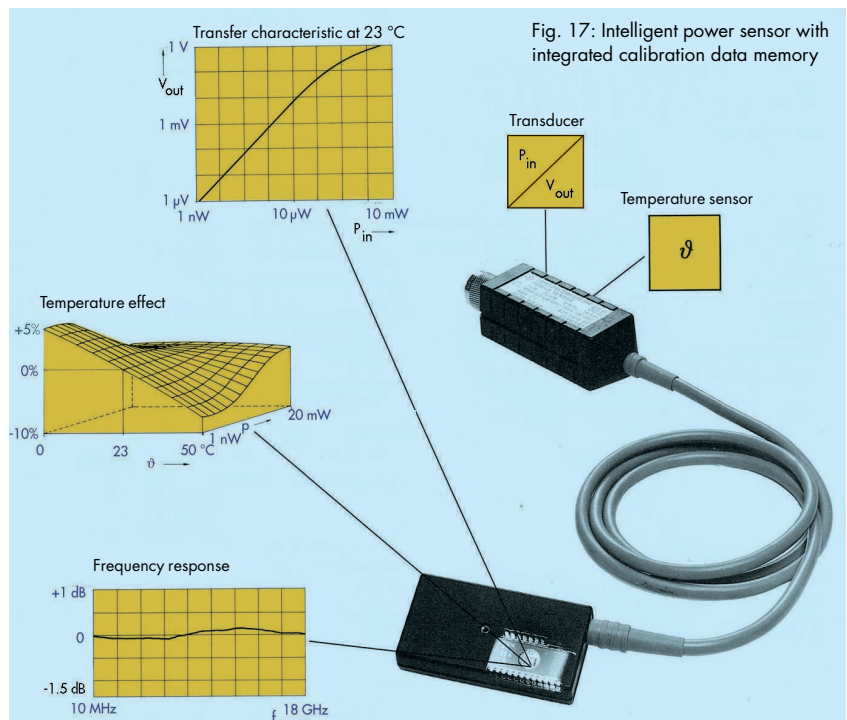

Fig. 17: Intelligent power sensor with integrated calibration data memory

WF 37902

Thermal Measurement Methods

Frequency range	Type of line/ Z_0 /connector
0.1 MHz to 4 (6) GHz	coax/50 Ω /N
10 MHz to 18 GHz	coax/50 Ω /N, PC 7
50 MHz to 26.5 GHz	coax/50 Ω /PC 3.5
50 MHz to 40 GHz	coax/50 Ω /K
50 MHz to 50 GHz	coax/50 Ω /2.4 mm
0.1 (1) MHz to 2.5 GHz	coax/75 Ω /N
12.4 to 330 GHz	waveguide, 15 frequency bands

Frequency ranges of commercial power sensors

width, waveguides are superseded by coaxial systems to an increasing extent.

With a few exceptions, power meters are of broadband design. Therefore they are less sensitive than selective test receivers or spectrum analyzers, but more accurate thanks to their simple design.

3.1.1 Thermal Measurement Methods

Thermal power meters are generally regarded to have little measurement uncertainty. One reason for the high accuracy is the high stability of calorimetric and related measurement methods, where the RF power is substituted by DC current or low-frequency AC current. Another reason is that with all thermal methods there are no weighting errors when power is converted into heat. In contrast to diode sensors, thermal sensors measure the average power, irrespective of the waveform of the signal. Harmonics are weighted

according to the magnitude of their power and there are no linearity errors with envelope-modulated signals.

The various measurement principles differ in the way the generated heat is measured. Depending on the state-of-the-art, different methods emerged as favourites in the course of development. At the end of the sixties, for instance, the Thermal Power Meter NRS from Rohde & Schwarz set new standards for precision power measurements. The power sensors operate as a bolometric detector with two sensors in a self-balancing bridge. This instrument is still used as a secondary standard by the German Calibration Service and the German Standards Laboratory. At present, thermocouple sensors are dominating in the industrial field, since they are superior as regards ruggedness, dynamic range and zero stability to all other types of

sensors (Fig. 18). Calorimetric measurements are still employed for very high powers in the kW and MW range as well as for calibration.

The smallest measurable power is determined by the sensitivity of the temperature sensor and the immunity of the test setup to ambient temperature fluctuations. The maximum permissible power is largely influenced by the heat resistance of the materials used. Under favourable circumstances, a measurement range of 30 dB to 50 dB can be achieved.

3.1.1.1 Thermocouple Sensors

Thermocouple power sensors are being offered nowadays for the entire microwave range. Although thermocouples were used in the past for temperature measurements, it was only through the combination of semiconductor and thin-film technology that fast, sensitive and yet rugged sensors

Fig. 18: Dual-Channel Power Meter NRVD with thermal power sensors for the frequency range from DC to 18 GHz



VF 43223-2

Thermocouple Sensors

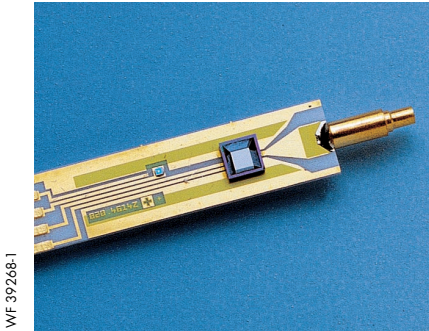

WF 39268-1

Fig. 19: Thermocouple of Power Sensors NRV-Z51 to -Z54

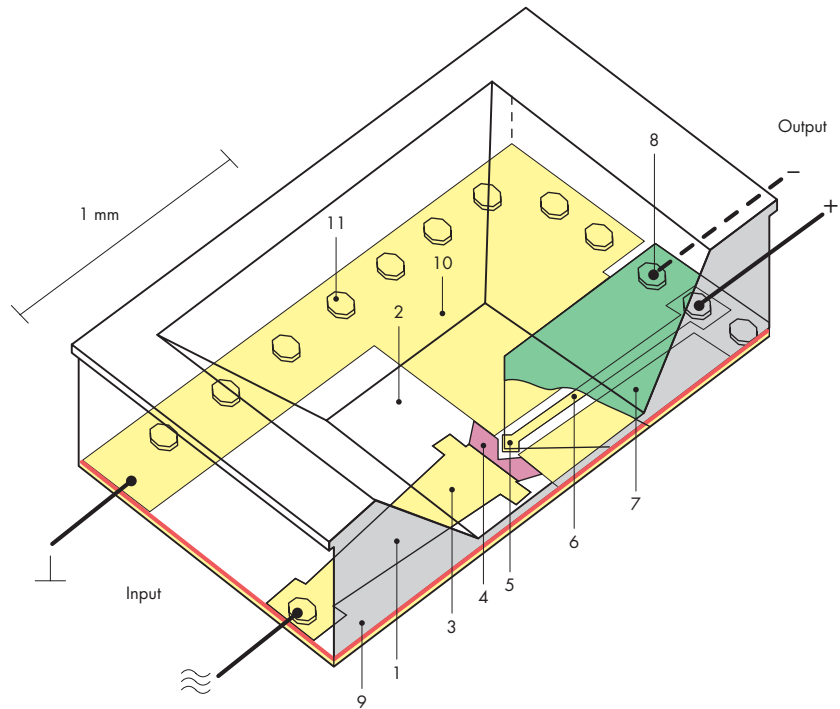

Fig. 20: Sectional view of measurement cell:

- | | |
|-------------------------------|--|
| 1 Silicon substrate | 6 Metal contact |
| 2 Membrane | 7 Highly-doped silicon layer |
| 3 RF feed | 8 Cold junction |
| 4 Termination | 9 Insulating layer (SiO ₂) |
| 5 Thermocouple (hot junction) | 10 Metallized ground |
| | 11 Bump |

could be produced (Fig. 19). The measurement cell is based on a silicon substrate (Fig. 20). The termination is a thin layer of tantalum nitride or chromium nickel, and a metal semiconductor contact in the immediate vicinity generates the thermoelectric voltage which is proportional to the converted RF power (approx. 200 $\mu\text{V}/\text{mW}$). The rated power is 100 mW.

To keep the manufacturing technique simple, termination and thermocouple are usually DC-coupled. A coupling capacitor is used for DC isolation from the measuring circuit. Large capacitors (high capacitance) needed for low frequency operation not only degrade matching but also reduce the upper frequency limit. Wide frequency bands can therefore be covered only with several sensors.

In the measurement cell developed for the Rohde & Schwarz Power Sensors NRV-Z51 to -Z55 the termination and the thermocouple are DC-isolated. This eliminates the need for a coupling capacitor and a single sensor can be used to cover the entire frequency range from 0 to 18 GHz (N connector), 0 to 26.5 GHz (PC 3.5 connector) or 0 to 40 GHz (K connector). The smallest measurable power is about 1 μW and at least ten times lower than with other thermal methods. This was made possible through a special design of the measurement cell which in conjunction with the poor heat conductivity of silicon makes for a good thermal insulation of the termination. The high thermal EMF of the metal semiconductor contact (approx. 700 $\mu\text{V}/\text{K}$) and the relative insensitivity of the thermoelectric effect to fluctuations of the ambient temperature are

also important factors. However, a slight degradation resulting from holding the sensor in the hand for some time or screwing it to a hot RF junction cannot be avoided altogether. Because heat is supplied at one end, there will be a temperature gradient across the measurement cell which produces additional thermoelectric voltages. The magnitude of these volt-

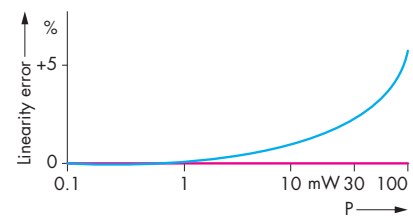

Fig. 21: Typical linearity error of thermoelectric cell (red: after numerical correction). The non-linearity is mainly caused by the temperature-dependent heat conductivity of silicon

Bolometers, Calorimeters

ages does not depend on the power, resulting in a zero shift of the transfer characteristic.

The ratio of thermoelectric voltage to RF power is also influenced by the magnitude of the input power. From about 10 mW, the transfer characteristic therefore becomes pronouncedly nonlinear (Fig. 21). With the sensors previously available on the market, this effect was compensated by analog means, resulting in residual errors up to about $\pm 5\%$ at the high end of the measurement range. Through individual calibration and numerical correction the linearity error of the NRV-Z thermal sensors can be kept below 0.5%.

The small mass of the sensor makes for a small thermal capacity and hence for a fast response (thermal time constant is of the order of ms or less). The temperature coefficient of the output voltage is either compensated by analog means or corrected numerically. To minimize microphonic effects and effects of thermoelectric voltages at the connectors of the connecting cable, the output signal of the sensor is boosted before it is taken to the power meter. Thermoelectric cells have an excellent long-term stability if they are used within their rated power range. A calibration generator is thus no longer required; it is only needed for sensors which do not have the numerical correction facility.

3.1.1.2 Bolometers

The term bolometer is used to describe power meters which are based on the variation of the electrical conductivity as heat is absorbed by the termination. There is a variety of bolometer

types, the best known of which are thermistors and barretters.

In the thermistor power meter, two semiconductor resistors with high negative temperature coefficient (thermistors) combine the function of termination and temperature sensor all in one. They absorb at the same time the RF power to be measured and a DC power (Fig. 22). In a bridge circuit, the DC resistance is measured and kept constant by varying the DC power. Any

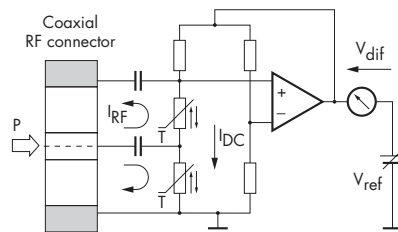

Fig. 22: Principle of thermistor power meter. the absorbed RF power can be calculated from the measured voltage difference V_{dif} . With the RF power switched off, V_{ref} is adjusted to give no voltage difference (zero adjustment)

increase of the RF power is thus always compensated by an appropriate reduction of the DC power and vice versa. The DC power can easily be measured. Due to the substitution principle employed, thermistor power meters feature an extremely high long-term stability and their effective efficiency (see further below) can be measured with a very low uncertainty. For general applications, these instruments have however become of little interest because of their narrow measurement range from 10 μ W to 10 mW.

Barretters make use of the positive temperature coefficient of metals. Common models have a thin platinum-wire filament to act as an RF absorber and temperature sensor. They feature a relatively low sensitivity and are easily damaged when the rated power is exceeded. Once widely used, they are nowadays obsolete and employed for very special applications only.

3.1.1.3 Calorimeters

Calorimeters in the original sense are instruments for measuring quantities of heat, ie energy/power is calculated from the temperature increase of a material of known specific heat capacity such as water. To enhance the measurement accuracy, commercial calorimeters operate on the substitution principle. Due to their high stability, they are used as primary standards. They are also used for the direct measurement of very high powers without attenuators or directional couplers connected ahead. For such applications, flow calorimeters are used (Fig. 23), partly with direct absorption of the RF energy in the cooling medium water.

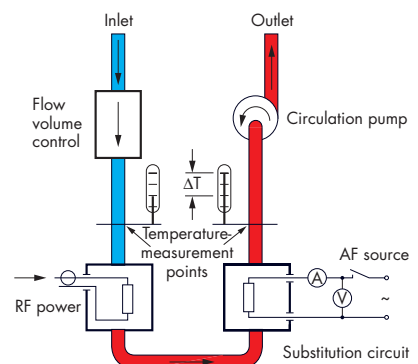

Fig. 23: Flow calorimeter using substitution method. The measured temperature difference is proportional to the absorbed power P. Calibration is made via the substitution circuit

Diode Sensors

3.1.2 Diode Sensors

In the early days of semiconductor technology, diodes were already used for power measurements in the RF and microwave bands, since their sensitivity was much better than that of thermal sensors. For such applications, germanium point-contact diodes had both a sufficiently low junction capacitance and a low dynamic resistance (video impedance) to enable low-noise measurement of the rectified voltage. Because of the fabrication technique involved, these detectors exhibited however large spreads in their electrical characteristics and instability so that for a long time diode power meters were regarded to be inaccurate.

Today, zero bias Schottky diodes produced on a silicon substrate or GaAs diodes are being mostly used. Their electrical characteristics are similar to those of the germanium point-contact diodes, but their long-term stability is as high as that of thermocouples. Diode power sensors cover the power range from below $10 \mu\text{W}$ down to about 100 pW . They are indispensable for measuring the peak or envelope power of modulated signals. Where a very high measurement speed is required, they are used instead of thermocouple sensors even in the power range from $10 \mu\text{W}$ to 100 mW . The measurement uncertainties occurring in this range must be traded off in each case against the measurement speed and zero stability. Diode sensors are made for frequencies up to about 110 GHz , often with plug-on attenuators for higher powers and for improved matching.

In addition to the termination, the sensor contains a half-wave or full-wave rectifier and a matching network for compensation of the junction capacitance and lead inductance of the diode (Figs. 24 and 25). Due to the parasitic circuit elements, matching is somewhat poorer than that of a comparable thermocouple sensor.

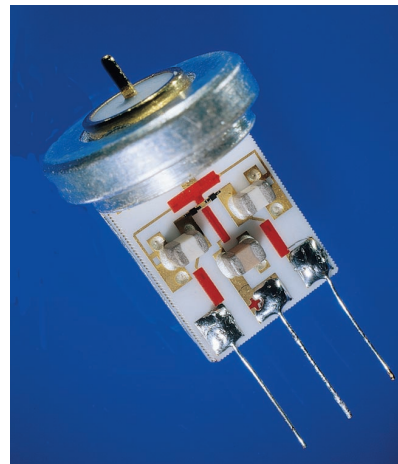

Fig. 24: Diode sensor of Power Sensor NRV-Z4

To improve it, the coupling capacitor between RF connector and termination is sometimes omitted. The output voltage is then not referred to ground but

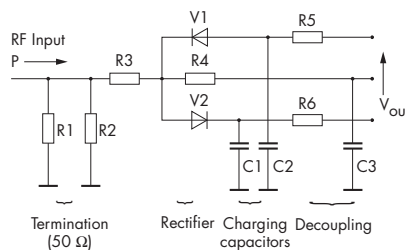

Fig. 25: Simplified block diagram of sensor

against the inner conductor or second rectifier so that the superimposed DC voltage is suppressed.

Even with DC coupling to the measurement circuit, the diode sensors cannot be used at very low frequencies. The frequency range is always limited by the charging capacitor which in conjunction with the DC resistance of the diode forms a highpass filter for the tapped RF voltage. Due to the unfavourable RF characteristics of high capacitances, very large frequency ranges can only be covered by several sensors. The measurement accuracy of a diode sensor is not only determined by the quality of calibration and matching, but to a considerable extent also by the magnitude of the power applied.

3.1.2.1 Square-Law Region

At very low powers, diodes behave very much like thermal power sensors. They measure the true RMS power and indicate neither dynamic nor frequency-dependent linearity errors. Harmonics are weighted according to their power, and the average power is indicated in the case of envelope modulation. In this range the diode behaves like a weakly nonlinear resistance (Fig. 26). In addition to the linear component (video impedance), the current-voltage characteristic also has a square term which causes RMS rectification. This section of the transfer characteristic is therefore also referred to as the square-law region. The output DC voltage is approximately proportional to the input power (about $800 \mu\text{V}/\mu\text{W}$) and the temperature coefficient is constant, its order of magnitude being the same as of thermocouple sensors.

Square-Law Region

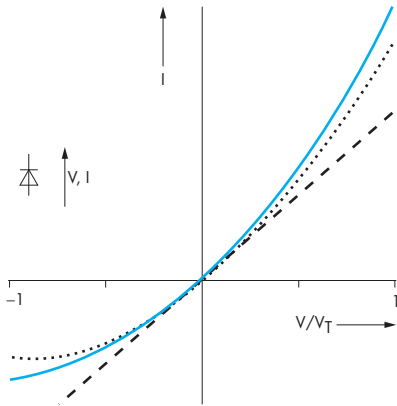

Fig. 26: Current-voltage characteristic of a Schottky diode in the square-law region (blue); dotted: square approximation; dashed: $I = V/R_0$, where R_0 is the video impedance without external bias; V_T = temperature voltage (25 to 35 mV)

There is no fixed upper limit for the square-law region. With sinusoidal signals, the upper limit is usually drawn at a crest value of 30 mV, corresponding to 10 μ W PEP in 50 Ω systems. At the lower measurement limit, with input powers between 100 pW and 1 nW, diode sensors output a very small DC voltage of a few hundreds of nV only. Superimposed thermal noise and zero drift caused by local heating of the sensor set a limit to the practical use of the diode.

3.1.2.2 Peak weighing

With increasing power level, the diode sensor changes from RMS weighting to peak weighting of the RF voltage, exhibiting the well-known behaviour of a diode rectifier. Highly stable, noise-free measurements are possible due to the relatively high output voltages of about 10 mV to a few V outside the square-law region. The measurement speed is extremely high. Since the static transfer characteristic (Fig. 27) is

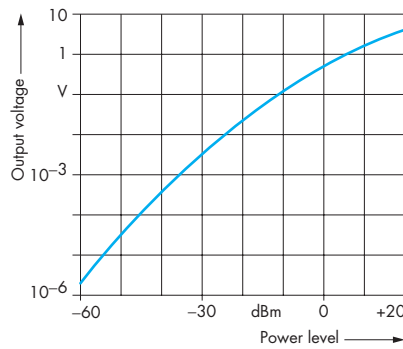

Fig. 27: Static transfer characteristics of a diode sensor with no-load output (full-wave circuit)

nonlinear and the temperature coefficient a complex function of power and temperature, power measurements outside the square-law region are not possible with older type power meters. Modern sensors can be appropriately calibrated so that residual measurement errors become negligible. Problems may be caused by effects which cannot be corrected subsequently, such as dynamic and frequency-dependent linearity errors as well as the effect of harmonics.

3.1.2.3 Measurement Errors Due to Harmonics

With non-sinusoidal signals, major measurement errors may occur outside the square-law region. While with low power levels applied to the sensor, there is a fixed relationship between output voltage and input power, outside the square-law region each waveform has its own transfer characteristic. Since sinusoidal voltages are used for calibration, other waveforms cause measurement errors which increase in proportion to the deviation of the crest factor of the voltage to be measured from $\sqrt{2}$. The ratio of peak to RMS

value is referred to as the crest factor. In the RF and microwave bands, measurement errors are mainly caused by broadband noise and signals with harmonics (Fig. 28). Measurement errors can be positive or negative depending on the phase of the harmonics.

The harmonic effect is almost exclusively dependent on the waveform and measured power. Contrary to

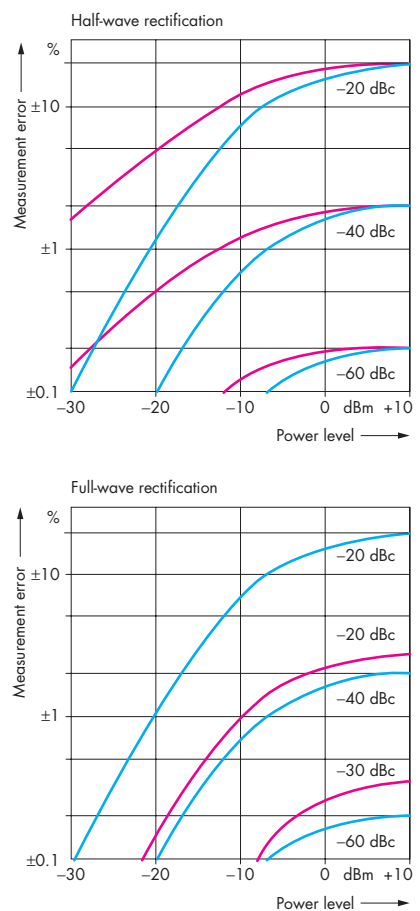

Fig. 28: Maximum measurement error of diode sensors in case of sinewave signals with harmonics (red: 2nd harmonic, blue: 3rd harmonic). Parameter: harmonics. Half-wave rectification shown in upper diagram, full-wave rectification in lower diagram

Linearity Errors

popular opinion, it cannot be reduced by a low-impedance load of the rectifier. An improvement can be achieved with full-wave rectifiers. They derive the average value from the positive and negative voltage peaks, thus eliminating the effect of even-numbered harmonics, in particular that of 2nd order (Fig. 29). As shown in Fig. 28,

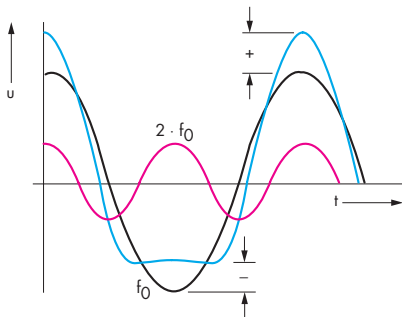

Fig. 29: Waveform distortion caused by 2nd harmonic; f_0 = fundamental frequency

considerable measurement errors may occur with half-wave rectification even within the square-law region.

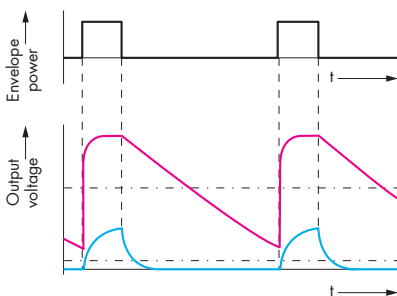

Fig. 30: Transfer characteristic of a diode sensor with pulse-modulated input signal within (blue) and outside (red) the square-law region; average values are dash-dotted

3.1.2.4 Dynamic Linearity Errors

Dynamic linearity errors occur in the measurement of the average power of modulated signals (Fig. 30). In the square-law region the charging and discharging time constants of the sensor are equal and the output voltage corresponds to the average power level. With increasing power level, the rise time decreases and the fall time increases because of the non-conduct-

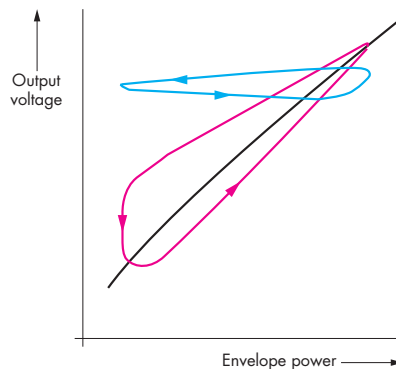

Fig. 31: Dynamic transfer characteristic of a diode sensor outside the square-law region with low-frequency (red) and high-frequency (blue) amplitude modulation (static characteristic in black)

ing diode. The output voltage is thus greater than the average power level. In the transfer characteristic, this is shown as a kind of hysteresis loop. Depending on the modulation frequency, the power and the discharge time constant of the sensor, the hysteresis loop lies somewhat above the transfer characteristic (Fig. 31). For modulation frequencies in the audio range, a fairly acceptable characteristic can be achieved by choosing a sensor with a very high lower cutoff frequency (small time constant).

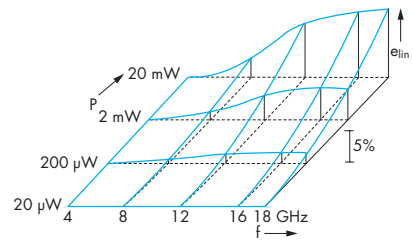

Fig. 32: Measured linearity error e_{lin} due to varactor effect of a 18 GHz detector

3.1.2.5 Frequency-Dependent Linearity Errors

Even with numerically linearized diode sensors linearity errors may occur outside the square-law region. They are caused by the voltage-dependent junction capacitance (varactor effect) and become evident when the diode starts affecting the RF behaviour of the sensor (as a rule of thumb: from 1/4 of the upper frequency limit). Since the junction capacitance decreases with increasing input power, there is normally an increase in the frequency response, i.e. the linearity error is positive (Fig. 32).

3.1.2.6 Peak Power Measurement

With high modulation frequencies and a voltage crest value of at least 1 V, any diode sensor can be used for measuring the peak power as can be seen from Fig. 31. However, it will be used for this purpose in exceptional cases only, since the measurement error very much depends on the waveform and power. For universal applications, there are special peak power sensors. They consist of a fast diode sensor followed by an amplifier and peak hold circuit. This principle is for instance employed with Peak Power Sensor NRV-Z31 from

Directional Power Sensors

Rohde & Schwarz. The charging time constant in the square-law region determines the lower cutoff frequency and rise time of the output voltage. To avoid dynamic measurement errors, the pulse width must be clearly greater than the specified rise time. Due to the relationship with the rise time, the lower cutoff frequency is still relatively high compared to that of normal diode sensors.

The rectified output voltage has a large noise component due to its wide bandwidth. Therefore it is not possible to measure powers that are considerably smaller than $1 \mu\text{W}$ with high accuracy. Peak power sensors are mainly

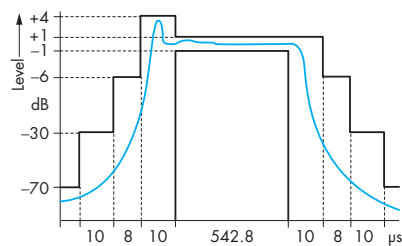

Fig. 33: GSM burst specifications and possible power envelope

used outside the square-law region. Such sensors are designed as full-wave circuits to minimize weighting errors with non-sinusoidal waveforms. Moreover, with modern sensors the frequency dependence of the linearity error is calibrated. Special sensors are available for TDMA radio networks. With these designs, the output signal of the rectifier is lowpass-filtered ahead of the peak hold circuit. Overshoots of the RF burst can thus be sup-

pressed on transmitter keying so that the power at the flat pulse top is indicated (Fig. 33).

3.1.2.7 Envelope Power Measurement

Diode sensors for envelope power measurements must not only be able to trace the leading edge, but the entire envelope of the test signal. For this purpose it is not sufficient to simply reduce the charging capacity. Additional measures are a low-impedance load connected to the sensor output or the output short-circuited. The short-circuit current is converted to a broadband output voltage by a current-to-voltage transducer. Pulse rise times in the range of a few ns require the entire signal path from the sensor through to the A/D converter to be designed for high frequencies. Since the short-circuit current is an exponential function of temperature, measurement errors greater than that of normal sensors are to be expected.

3.1.3 Directional Power Sensors

Directional sensors are connected between source and load to measure the power flow in both directions. They are fitted with a double directional coupler (reflectometer) to provide for separation between forward and reflected wave. The signals coupled out are measured by separate diodes for the incident and for the reflected power. Fig. 34 shows the block diagram of a sensor for the Power Reflection Meter NAP from Rohde & Schwarz.

The sensors can be coupled to the main line so that either the square-law region or the entire characteristic is used. There are no strong pros or cons for the two possible designs. The main advantage of the square-law region is the absence of dynamic linearity errors. Appropriately designed sensors are ideal for measuring the average power of envelope-modulated signals. If on the other hand the entire characteristic is used, a much greater power range can be measured. This may be of advantage for SWR measurements where only little power is available. Accurate measurements are also possible with well-matched loads and therefore low reflected power.

Harmonics are of minor importance, at least in radiocommunications, since a high degree of harmonic suppression is prescribed by regulations. Some sensors can measure the peak power, the output signal of the sensors being boosted and applied to a peak hold circuit before it is transferred to the power meter.

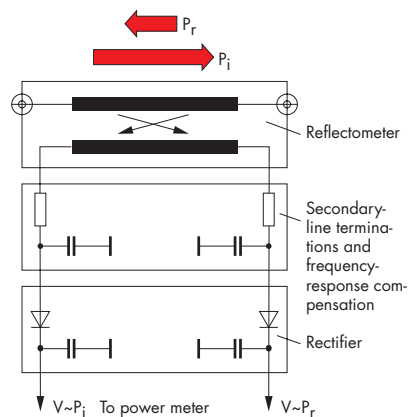

Fig. 34: Block diagram of sensor for use with Power Reflection Meter NAP in the frequency range 25 to 1000 MHz

Directional Couplers



Fig. 35: Directional Power Sensor NRT-Z44 for the frequency range 200 MHz to 4 GHz

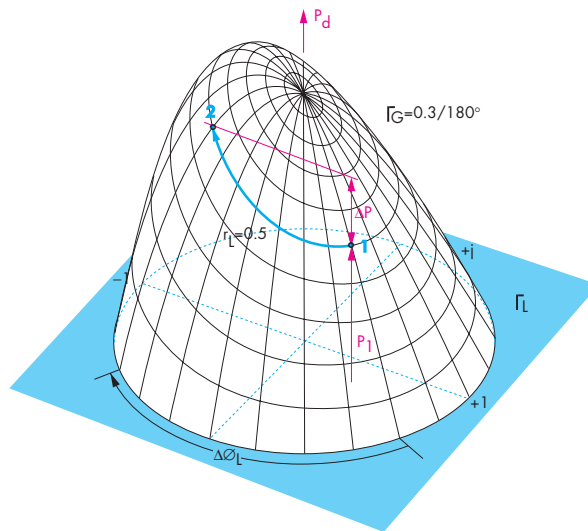

Fig. 36: The insertion of a directional sensor may cause considerable power changes (1 → 2) if source and load are mismatched

3.1.3.1 Directional Couplers

The main features of a directional power sensor, such as measurement accuracy, matching, frequency and power range are determined by the directional coupler. Due to rather small dimensions, line couplers with short secondary line, directional couplers with lumped components or similar designs are suitable for use with directional power meters. For the frequency range up to 100 MHz, the lumped coupler designed by Buschbeck is mostly used.

Due to the directional coupler, directional power sensors are always somewhat more narrowband than the terminating power sensors, covering a bandwidth between one octave and little more than two decades. The rated power ranges from a few W to some kW. It can relatively easily be influenced by the coupling coefficient, with hardly any change to the power absorbed by the directional sensor. Reflection coefficient and insertion loss of the directional coupler are usually

negligible. This holds true at least for the lower band limit, where there is only a loose coupling between main line and secondary line. Depending on the type of coupler, the coupling coefficient may increase with the frequency, resulting in more power being taken from the main line and an increase in the insertion loss. With broadband sensors of low rated power, insertion losses up to about 0.5 dB may thus occur at the upper frequency limit.

Even with a loss-free and ideally matched directional sensor the insertion into the test circuit may cause a change to the power flow (Fig. 36). The cause lies in a change of the phase between source and load reflection coefficient due to the line being extended by the inserted sensor. In the worst case, deviations attain twice the mismatch uncertainty. This effect need not be considered at the output of level-controlled sources, since the incident power is stabilized.

3.1.3.2 Directivity

The directivity of the coupler, ie its ability to separate incident and reflected power, has a decisive influence on the measurement accuracy. The directivity α_D is used to describe the level difference between indicated incident power P_i' and indicated reflected power P_r' for a reflection-free matched load (Fig. 37):

$$\alpha_D = 10 \text{ dB} \log_{10} \frac{P_i'}{P_r'} \text{ for } r_L = 0 \quad (21)$$

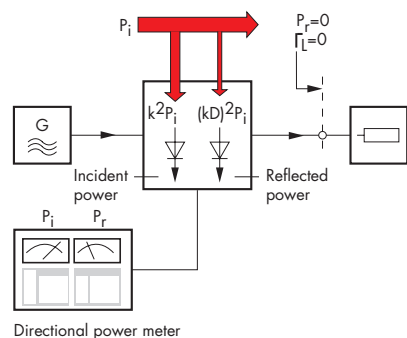

Fig. 37: Measurement of directivity (k = coupling coefficient; D = directivity factor)

Coaxial Voltage Probes

The greater the difference, the better the directivity. Standard values for directional sensors lie between 25 dB and 35 dB.

In addition to the logarithmic directivity expression, the linear directivity factor D is also used:

$$D = 10^{\frac{\alpha_D}{20 \text{ dB}}} \quad (22)$$

D is between 0 (ideal case) and 1 (no directivity).

Inadequate directivity is clearly shown in the indicated reflected power P_r' , but it also influences the measured incident power P_i' . Due to the unknown phase relationship between the forward and reflected wave, neither magnitude nor sign of the resulting measurement errors are predictable. There are measurement uncertainties which the manufacturer is not able to specify and which the user has to estimate.

The measurement uncertainty for the reflection coefficient is very easy to determine. Based on the measured values P_r' and P_i' , the reflection coefficient of the load is derived from the following relationship or read out directly:

$$r_L' = \sqrt{\frac{P_r'}{P_i'}} \quad (23)$$

The true value may be greater or smaller by the directivity factor D :

$$r_L' - D \leq r_L \leq r_L' + D \quad \text{for } D \leq r_L' \quad (24)$$

$$0 \leq r_L \leq r_L' + D \quad \text{for } D > r_L' \quad (25)$$

From this follows that the matching of loads, whose reflection coefficient is smaller than the directivity factor, cannot be reasonably measured. To put it another way, the directivity should at least be as high as the expected return loss. Equations 24 and 25 only take into account the effect of the directivity on the indicated reflected power and this is sufficient in case of a well-matched load. Generally, the effect on the indicated incident power (see further below) must also be considered. The corresponding measurement uncertainty for the return loss is given in Fig. 38.

The measurement error for the incident power (ϵ_D) can be derived from a formula analogous to the mismatch uncertainty. In place of the reflection coefficient r_G , the directivity factor D is used to obtain the following approximations

$$\epsilon_{D\%} \approx 200 \% D \cdot r_L \quad (26)$$

$$\epsilon_{D\text{dB}} \approx 8.7 \text{ dB } D \cdot r_L \quad (27)$$

with a validity range of about 20% or 1 dB (Fig. 39).

The relative measurement error for the absorbed power, which is calculated from the difference between indicated incident and reflected power, can be looked up in Fig. 40.

3.14 Coaxial Voltage Probes

Coaxial voltage probes with diode rectifiers (see photo on page 9 bottom) may also be used for power measurements. They are available for frequencies up to about 3 GHz and a very

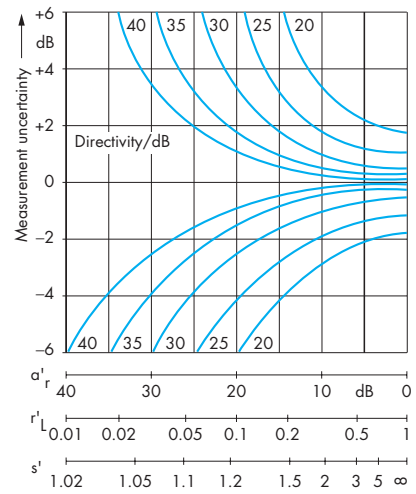

Fig. 38: Maximum measurement uncertainty for return loss due to insufficient directivity; a_r' , r_L' , SWR' = measured return loss, reflection coefficient and SWR

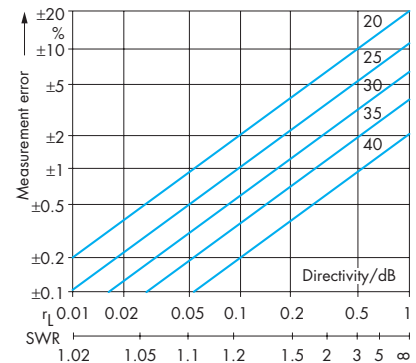

Fig. 39: Maximum measurement error for incident power due to insufficient directivity

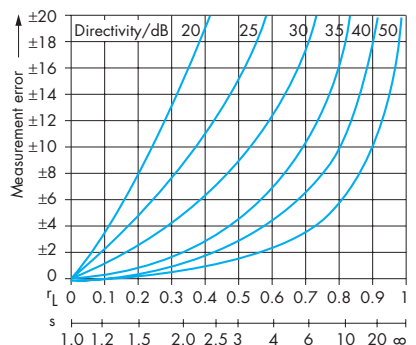

Fig. 40: Maximum measurement error for absorbed power due to insufficient directivity

Basic Units

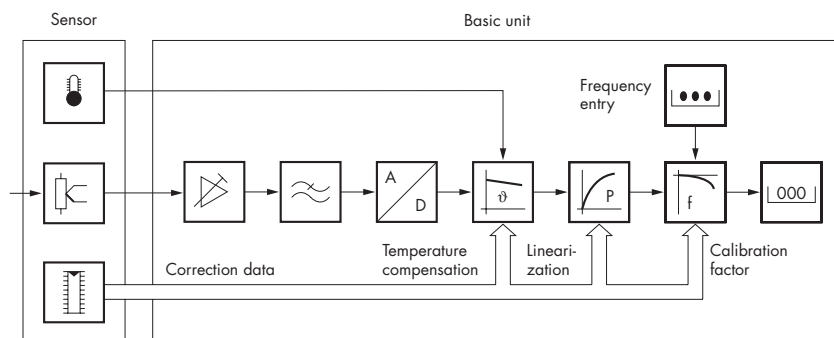

Fig. 41: Power meter with numerical correction of sensor-specific parameters (NRVS and NRVD)

favourably priced alternative for measuring the incident power with well-matched loads or when requirements on the measurement accuracy are not high. Modern probes provide all facilities of intelligent error correction. The rectifier is connected to the inner conductor either directly or via a capacitive 10:1 attenuator. The attenuator allows almost complete decoupling of the rectifier. Therefore, such probes exhibit an excellent matching and low insertion loss over the entire useful frequency range.

3.2 Basic Units

The basic power meters have the task of processing the output signal from the sensor (Fig. 41). With the exception of envelope sensors, the sensor signals are usually low DC voltages with superimposed residual low-frequency modulation. They are boosted in a low-noise and low-drift chopper amplifier to a level where they can be digitized. The AC component is suppressed by lowpass filters or the A/D converter itself. Modern instruments feature an extensive numerical correction of the measured values based on the sensor-

specific data. The frequency has to be entered by the user. The corrected results can be output on the display or via a remote-control interface.

3.2.1 Zeroing

With all power meters, there are additional measurement errors at the lower measurement limit due to superimposed interference. Thermocouple sensors and diode sensors are mainly

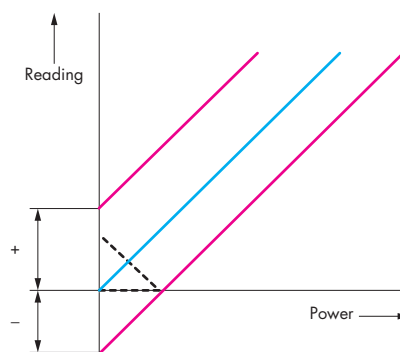

Fig. 42: Zero offset

affected by thermal voltages and offset voltages in the chopper amplifier. Ther-

mal voltages are produced by exposing the junctions of different materials to temperature gradients. The offset and thermal voltages shift the transfer characteristic of the sensor from the origin by an amount independent of the measured power (Fig. 42). The resulting zero offset is the greater, the smaller the measured power.

This effect can be corrected for all power meters by zeroing. For this purpose, the power to be measured must be disconnected first. One should also avoid to touch the sensor so that no additional thermal voltages will be produced. The residual offset after zeroing and the display noise determine the sensitivity of the power meter.

3.2.2 Display Noise and Measurement Speed

Display noise causes jitter of a meter pointer or flickering of a digital readout. Like the zero offset, display noise is an additive error independent of the measured power. By reducing the measurement bandwidth, display noise can be traded off for measurement speed (Fig. 43). Usually, the

Calibration

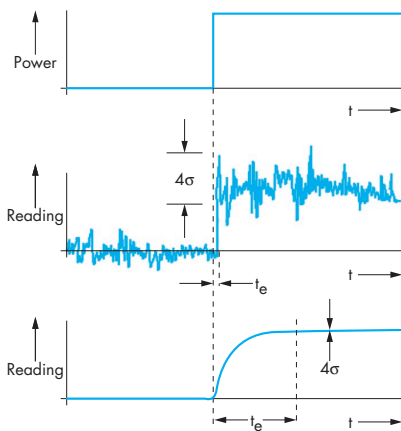

Fig. 43: Display noise and dynamic behaviour of a power meter without (center) and with display filter (bottom)

measurement results are numerically averaged, partly using analog prefiltering. Depending on the measuring instrument, filtering can either be selected by the user or set automatically. The smaller the power, the more effective must be filtering.

A meaningful indication of the minimum power specified for a sensor is as a rule only possible with high noise filtering, settling times from 10 s to 30 s being not unusual (Fig. 44). Short measuring times of about 0.1 s can only be achieved at higher power levels, with thermocouple sensors in the relatively narrow range from 1 mW to 100 mW. Diode detectors, which can be operated beyond the rectifier square-law region, have the advantage that they allow a power range of 40 dB to be measured at maximum speed. They are therefore ideal for use in automatic test systems. Since the display noise causes random measurement errors, it has to be described as a statistical error. It is usually specified as twice the standard deviation (2σ) corresponding to a confidence level of 95%.

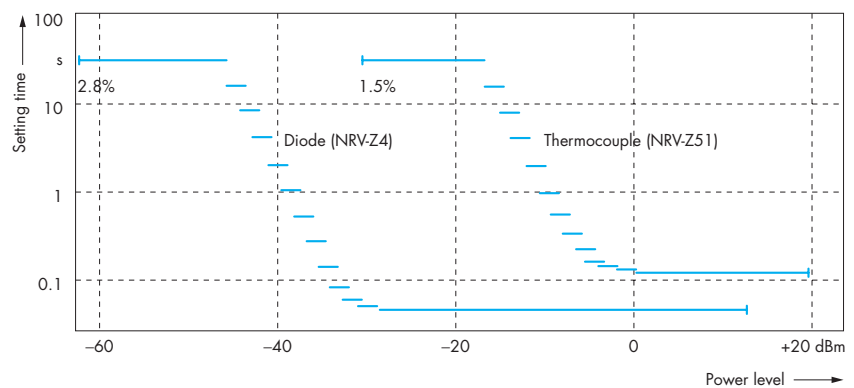

Fig. 44: Settling time as a function of measured power. The display filter is set so that the relative noise component (2σ) remains within 0.1%. Only with the filter set to maximum, the noise component rises to the specified value with the measured power further decreasing

3.2.3 Envelope Analyzers

The basic units are similar in design to digital oscilloscopes. Broadband amplification of the sensor signal is followed by digitization with a fast A/D converter. Periodical signals can be displayed with high time resolution by random sampling. As with average-weighting power meters, the display noise can be reduced by limiting the bandwidth, which may cause smoothing of the pulse edges. For correcting sensor-specific characteristics, the same methods are used as with average-weighting power meters.

3.3 Calibration

The output signal of high-frequency power sensors is a complex function of measured power, frequency and temperature. Since an adjustment of the high-frequency sensor is not possible for practical reasons, the individual characteristics must be determined by

means of calibration. The determination of a single, frequency-dependent proportionality factor is sufficient in few cases only. With modern sensors, the calibration data are stored in a digital memory connected with the sensor and numerically processed in the basic unit.

3.3.1 Terminating Power Sensors

Terminating sensors can be calibrated so that either the power P_d absorbed at the reference plane or the incident power P_i is indicated (Fig. 45). Usually, indication of the incident power is calibrated. The power P_{GZ0} of the source delivered to Z_0 load can then be measured. With older power meters, the calibration parameter is referred to as the calibration factor. For ease of understanding, one should assume that the power delivered to Z_0 load is to be measured in the special case of a matched source (Fig. 46). After con-

Calibration

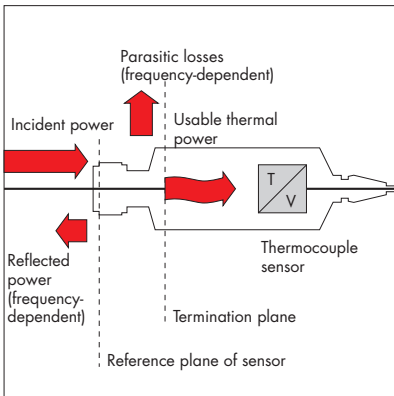

Fig. 45: Power distribution in a thermocouple sensor. The absorbed power is equal to the sum of usable thermal power and parasitic losses

nection of the sensor, the incident power will be of the value P_{GZ0} (equation 12), whereas the power absorbed at the reference plane will be smaller by the mismatch loss of the sensor. To ensure that the power indication is independent of the reflection coefficient of the sensor, the sensor must be calibrated for the incident power.

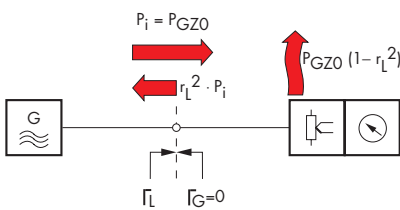

Fig. 46: Power measurement on matched source

Despite correct calibration, measurement errors may occur if both ends, that is source and sensor, are mismatched. In this case, the incident power is dependent on the magnitude and phase of the two reflection coeffi-

cients and usually differs from the power delivered to Z_0 load. This measurement error cannot be corrected and is entered into the measurement result as a mismatch uncertainty (see Fig. 10). Since the source is given, the mismatch can only be influenced by the sensor. The better the sensor matching, the lower is the measurement uncertainty.

A considerably higher accuracy can be obtained when measuring the maximum available power $P_{G \max}$ of the source instead of the power delivered to Z_0 load. For this purpose, the sensor must be conjugate matched to the source via a tuner and calibrated for indication of the power absorbed at the reference plane (see Fig. 7). This method of calibration is used for high-precision standards with thermistors. The calibration parameter is the ratio of the thermal power P_{therm} to the absorbed power P_d at the reference plane. It is referred to as the effective efficiency η_e and always smaller than 1 due to the parasitic losses between RF connector and termination.

$$\eta_e = \frac{P_{\text{therm}}}{P_d} \quad (28)$$

It may at times be necessary to measure the absorbed power with a power meter calibrated for incident power. If the reflection coefficient r_L of the sensor is known, the equation

$$P_d = P_i(1 - r_L^2) \quad (29)$$

can be used for conversion.

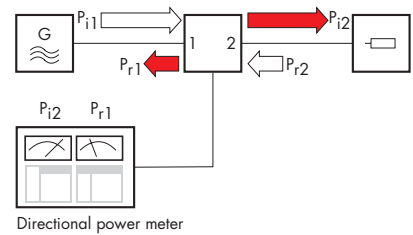

Fig. 47: Calibration of directional power meters

3.3.2 Directional Power Sensors

Directional sensors are usually calibrated for indication of the outgoing power (Fig. 47). This means that the power incident to the load is indicated, as desired, but unfortunately also the reflected power referred to the source connector of the power sensor. For SWR measurements, the resulting measurement error is negligible even if the sensor exhibits a somewhat higher insertion loss. Considerable measurement errors may however occur if the power absorbed by the load is to be measured with incident and reflected power being approximately equal. In this case, the indicated reflected power must be increased by the amount of the insertion loss of the directional power sensor.

3.3.3 Coaxial Voltage Probes

Coaxial voltage probes are calibrated for indication of the incoming or outgoing power. Details can be taken from the manufacturer's documentation.

Thomas Reichel

Definitions of Voltage and Power Measurements

Adjustment

Adjustment means to set or adjust a measuring instrument so as to minimize measurement errors or to ensure that the measurement errors do not exceed the error limits. Adjustment requires an action which usually causes a permanent change to the measuring instrument.

Calibration

Calibration is used to determine the response of a measuring instrument relative to a reference instrument of higher accuracy. Although the calibration process itself is error-prone, systematic measurement deviations can be numerically determined and taken into account in subsequent measurements.

For the majority of power meters, only the frequency response of the sensor is calibrated, i.e. the variation of the ratio between output voltage of the RF sensor and input power relative to a reference frequency. This kind of calibration makes it necessary that prior to a measurement each sensor has to be subjected to an absolute calibration with the aid of a precise power reference (usually 1 mW, 50 MHz). Apart from the inconvenience of this procedure, incorrect manual calibration or

operator's errors cannot be excluded. Errors often arise especially if the operator has to rush through the measurement. Moreover, this calibration method does not take account of the nonlinearity of the sensor and its response to temperature variations.

To eliminate all these error sources, all sensors of the URV5-Z, NRV-Z and NRT-Z series are absolutely calibrated. An integrated ROM contains all the relevant data: individual sensitivity for a large number of frequencies, nonlinearity, temperature effect and general data such as date of calibration, etc. Whenever a sensor is connected to the meter, these calibration data are read out and used for calculating the measurement result. Operator's errors are excluded and the accuracy of the results is considerably increased.

Crest Factor

The crest factor is the ratio of peak to RMS value of an AC voltage and an essential criterion in the measurement of non-sinusoidal AC voltages with an RMS voltmeter.

This term is used similarly in power measurements where it is defined as the ratio of peak envelope power to average power.

Directivity

Directional power meters are able to measure the power flow on a coaxial line separately for the forward and the reflected wave. For this purpose they are fitted with a dual directional coupler (reflectometer) of symmetrical design with two test outputs. Each of the two test outputs is assigned one of the two power flow directions in the main line. In the ideal case, the power is coupled out from the wave in the preferred direction only, which however is not possible in practice. The selectivity of the directional coupler is expressed in terms of its directivity. The directivity is a logarithmic measure in dB stating the amount of change of the power coupled out when the power flow direction is reversed. The higher the directivity, the better the matching of the load can be determined by a directional power meter. A high directivity also reduces the measurement uncertainty for the incident power in the case of a load with poor matching.

Frequency Response

The frequency response of a measuring instrument is defined as the measurement error being a function of frequency, relative to a reference frequency.

Definitions

German Calibration Service (DKD)

Roof organization of industrial calibration laboratories in the Federal Republic of Germany. The German calibration laboratories can offer calibration services for a variety of important physical parameters approved by the German Standards Laboratory (PTB).

IEC/IEEE Bus

The standard remote-control interface in electronic measurements. It is an addressable parallel data interface allowing simultaneous control of several instruments. Usually it is provided on a separate interface card and requires additional programs for the process controller used. With the international standardization of the command syntax for the SCPI standard (Standard Commands for Programmable Instruments) the standardization work has come to an end for the time being.

Input Impedance

In electronic voltmeters with an input amplifier, the input impedance is generally high and can be represented by an ohmic resistance and a lossy capacitance in parallel. For broadband

voltmeters an input impedance of about $1\text{ M}\Omega \parallel 40\text{ pF}$ can be assumed. At 10 MHz the parallel capacitance gives an input impedance of as low as $500\ \Omega$. A connected coaxial cable makes the input impedance even lower. The input impedance can be increased by using a voltage divider probe (10:1, 100:1) or an active probe.

With diode probes the AC voltage to be measured is applied to a diode rectifier without input amplifier. At the lower frequencies, the diode probes are not as high-impedance (approx. $100\text{ k}\Omega$) as voltmeters with an input amplifier. Due to their low input capacitance of approx. 2 pF , the input impedance is much higher at a few MHz. Using plug-in dividers, the capacitance can be reduced to about 0.5 pF at the sacrifice of sensitivity and the input impedance thus further increased. Diode probes permit high-impedance measurements up to frequencies of 1 GHz.

Matching

For a quantitative description of this term the parameters reflection coefficient, return loss and SWR are used. Extremely low reflection coefficient or an SWR with an ideal value of 1 or very high return loss are basic requirements. The effect of mismatch on the measurement accuracy is often under-

rated. Only with a well-matched sensor can this effect be kept low since the measurement errors caused by mismatch are determined by the product of the reflection coefficient of source and sensor and the matching of the source – that is the DUT – can usually not be changed. All URV5 and NRV sensors therefore feature very low reflection coefficients. If several, equally good sensors are available for a measurement, the one with the lowest reflection coefficient should be chosen. Usually, it also has the lowest calibration uncertainty.

Measurement Error

The measurement error is defined as the difference between a measured value and a reference value that is usually furnished by a high-precision measuring instrument. In the ideal case the reference value is the "true" value of the measurand that cannot be measured however. Error limits are the maximum permissible measurement errors specified by the manufacturer of the measuring instrument. If these error limits are exceeded, the measuring instrument is considered to be faulty.

The accuracy of power meters is usually not specified in terms of error limits. Manufacturers rather state the measurement uncertainty for the determination of the calibration factors (calibration uncertainty).

Definitions

Measurement Uncertainty

Measurement uncertainty is a parameter that characterizes the accuracy of a measurement and is associated with the result of a measurement or calibration. More precisely, the measurement uncertainty characterizes the range of values that can reasonably be attributed to the measurand.

According to international practice, the specification of measurement uncertainty limits (worst case) has meanwhile been replaced by the so-called expanded uncertainty with a coverage factor of 2. With normal distribution of the measurement errors, it can be assumed that the measurement result is with 95% probability within the interval defined by the expanded uncertainty.

The expanded measurement uncertainty is determined statistically taking into account all parameters influencing the measurement. The method is described in detail for instance in the "Guide to the Expression of Uncertainty in Measurement" published by the International Organization for Standardization (ISO).

National Laboratory

National authority responsible for establishing, maintaining and disseminating standards for physical quantities (eg power) with lowest possible uncertainty. In the Federal Republic of Germany this task is performed by the German Standards Laboratory (PTB) and in the United States by the National Institute of Standards and Technology (NIST, formerly NBS).

Nonlinearity

Nonlinearity or linearity error of a measuring instrument is the deviation from a linear relationship between measured quantity and displayed value.

Official Calibration

Testing of a measuring instrument by a calibration authority in line with certain calibration standards. A stamped label certifies that at the time of testing the measuring instrument has complied with the calibration standards and that due to the nature of such instrument it can be expected that with proper handling it will adhere to specifications until the next recalibration becomes due. The measuring instruments subject to official calibration are governed by legal provisions.

Peak Power

Amplitude modulation (AM) and many digital modulation methods cause a modulation of the envelope of the carrier signal. The peak power is defined as the power at the modulation maximum averaged over one cycle of the carrier signal. To avoid confusion with the peak value of the instantaneous power, the term peak envelope power (PEP) should rather be used instead of peak power.

Peak-Responding Rectification

Voltmeters with peak-responding rectification measure the peak value of a periodic signal. They have a storage capacitor which holds the peak value. Distinction is made between positive peak (V_{p+}), negative peak (V_{p-}) and peak-to-peak rectification (V_{pp}).

PEP

The acronym PEP stands for peak envelope power which is the carrier power at the highest crest of the envelope averaged over one cycle (peak power).

Definitions

RMS-Responding Rectification

The RMS value is the most widely used parameter to determine the magnitude of an AC voltage. It is defined so that a DC voltage of this magnitude produces the same heat dissipation at an ohmic resistance as the AC voltage measured. The mathematical expression (where T_i is the integration time) is:

$$V_{\text{rms}} = \sqrt{\frac{1}{T_i} \cdot \int_0^{T_i} v^2(t) dt}$$

Squaring of the measured voltage may – in line with the definition – be made thermally by means of nonlinear electronic components or numerically following a sampling process. Rohde & Schwarz uses a patented circuit in the RMS Voltmeters URE 2 and URE 3 whose benefits are great accuracy, high crest factor, wide frequency range and short settling time.

RS-232 Interface

A serial data interface, one or several of which are fitted as standard in most of the PCs. A mouse or a plotter can for instance be connected to the RS-232 interface – or a Level Meter URV 35 remote-controlled. The interface is bidirectional, that means that data can be sent or received. Each data word is sent as a bit stream, with start and one or two stop bits, at a fixed clock rate, ie the transfer rate. The usual data format consists of 8 data bits, one start and one stop bit, ie 10 bits per character.

Sensitivity

The sensitivity of a measuring instrument is defined as the ratio of the response of an output quantity (the displayed value) to the variation of the measured quantity. If the sensitivity depends on the magnitude of the measured quantity, the response is referred to as nonlinear.

Square-Law Region

The square-law region of diode detectors is the range of the input voltage or input power within which the output DC voltage is proportional to the square of the input voltage or – being equivalent – the input power (RMS-responding rectification).

Standard deviation

Standard deviation is a measure of the average deviation of a discrete random variable from its average value. This term is also used in measurement technology to characterize noise signals. It can be shown that the standard deviation of a sequence of sampling values of a noise voltage (without DC voltage content) is equal to the RMS value of this voltage.

Testing

Checking the device under test for compliance with one or several given conditions. A measuring instrument for instance can be tested for compliance with the specified error limits.

Thermal Power Measurement

Thermal power meters allow an almost error-free conversion of RF power into a quantity that can be measured more easily, eg the temperature rise in a terminating resistor.

Earlier designs of this type of power meters usually had the disadvantage of a low measurement speed, since the thermal time constant of the termination and of the thermal sensor was not small enough. However, semiconductor technology has now made it possible to achieve an effective time constant of a few milliseconds only, eg in the Power Sensor NRV-Z55. For this sensor, a new method has been adopted which allows DC coupling of the signal, so that a single sensor can cover the entire frequency range from DC to 40 GHz.

References

- Barnard, D.L. et al.: Automatic Calibration for Easy and Accurate Power Measurements. *Hewlett-Packard Journal*, Vol. 43 (April 1992), pp. 95-100.
- Bailey, A.E et al.: Microwave measurement. Peter Peregrinus Ltd., London, UK 1985.
- Betz, T.: New mobile-radio technology, new test equipment: Directional Power Meter NAS with GSM insertion unit NAS-Z6. *News from Rohde & Schwarz No. 139* (1992), pp. 32-33.
- Betz, T.: Directional Power Meter NAS for any radio system. *News from Rohde & Schwarz No. 134* (1991), pp. 29-30.
- Betz, T.: Power sensors for NRV now up to 26.5 GHz. *News from Rohde & Schwarz No. 133* (1991), pp. 34-35.
- Betz, T.: URE 2 and URE 3 – evolution and revolution in RMS voltmeters. *News from Rohde & Schwarz No. 127* (1989), pp. 8-11.
- Betz, T.: HF-Spannung und HF-Leistung perfekt gemessen. *Elektronik*, Vo. 35 (1986), No. 13, pp. 171-174.
- Betz, T.; Köhler, D.; Reichel, T.: RF Millivoltmeter URV 5 – voltage and power measurement into the gigahertz range. *News from Rohde & Schwarz No. 106* (1984), pp. 16-18.
- Betz, T.; Birner, R.; Reichel, T.; Schermer, J.: Schaltung zum Messen des Effektivwerts einer Wechselspannung. German Patent DE 31 43 669 C2, Sept. 83.
- Blackham, D; Hoberg, P.: Minimize Harmonics in Scalar Tests of Amplifiers. *Microwaves & RF*, Aug. 1987, pp. 143-153.
- Blankenburg, K.H.: Quadrier- oder Effektivwertgleichrichter-Schaltung. German Patent DE 23 29 579 B2, Aug. 79.
- Blankenburg, K.H.: Waveform weighting for RF voltage measurements using RF-DC Millivoltmeter URV. *News from Rohde & Schwarz No. 75* (1976), pp. 22-24.
- Browne, J.: SNA Sensors Trigger on Fast Pulses. *Microwaves & RF*, July 1990, pp. 132-137.
- Buschbeck, W.: Hochfrequenz-Wattmeter und Fehlanpassungsmesser mit direkter Anzeige. *Hochfrequenz und Elektroakustik* 61 (1943) No. 4, S. 93.
- Burns, J.G.: Vector Analyzer speeds Power Sensor Calibration Results. *Microwaves & RF*, Aug. 1987, pp. 91-96.
- Cordes, H.: Messung der Spitzenleistung bei Mikrowellen. *Elektronik*, Vol. 34 (1985), No. 24, pp. 126-127.
- Daw, E.: Determine the Accuracy of loss measurements. *Microwaves & RF*, Jan. 1984, pp. 73-79.
- DIN 1319, Part 1, June 1985: Grundbegriffe der Meßtechnik – Allgemeine Grundbegriffe.
- DIN 1319, Part 2, Jan. 1980: Grundbegriffe der Meßtechnik – Begriffe für die Anwendung von Meßgeräten.
- DIN 1319, Part 3, Aug. 1983: Grundbegriffe der Meßtechnik – Begriffe für die Meßunsicherheit und für die Beurteilung von Meßgeräten und Meßeinrichtungen.
- DIN 1319, Part 4, Dec. 1985: Grundbegriffe der Meßtechnik – Behandlung von Unsicherheiten bei der Auswertung von Messungen.
- Engen, G.F.: Amplitude Stabilization of a Microwave Signal Source. *IRE Transactions on Microwave Theory and Techniques*, April 1958, pp. 202-206.
- Fantom, A.: Radio frequency and microwave power measurement. Peter Peregrinus Ltd., London, 1990.
- Fischer, C.M. et al.: GaAs Technology in Sensor and Baseband Design. *Hewlett-Packard Journal*, April 1992, pp. 90-94.
- Fundamentals of RF and Microwave Power Measurements. Application Note 64-1, Hewlett Packard, 1977/78.
- Harrison, R.G.; Le Polozec, X.: Nonsquarelaw Behavior of Diode Detectors Analyzed by the Ritz-Galérkin Method. *IEEE Transactions on Microwave Theory and Techniques*, Vol. 42, No. 5 (May 1994), pp. 840-845.
- Heiden, K.P.: Ausgangsleistung und Anpassung. *Funkschau*, Vol. 50 (1978), No. 19, pp. 915-918 (I) and No. 20, pp. 967-968 (II)
- Hunton, J.K.: Analysis of Microwave Measurement Technique by Means of Signal Flow Graphs. *Transactions IRE*, Vol. MTT-8, No. 2 (March 1960), pp. 206-212.
- ISO Guide to the Expression of Uncertainty in Measurement. First edition 1993, corrected and reprinted 1995, International Organization for Standardization, Geneva, Switzerland, ISBN: 92-67-10188-9, 1995.
- Jackson, W.H.: A Thin-Film/Semiconductor Thermocouple for Microwave Power Measurements. *Hewlett-Packard Journal*, Vol. 26, No. 1 (Sept. 1974), pp. 16-18.
- Janik, D., Wolf, H.: Leistungsmessung im Millimeterwellengebiet bei Raum- und Stickstofftemperaturen mit Dünnschicht-Bolometern. *Technisches Messen* 62 (1995), pp. 49-57.
- Johnson, R.A.: Understanding Microwave Power Splitters. *Microwave Journal*, Dec. 1975.
- Käs, G.; Pauli, P.: Mikrowellentechnik. Franzis, München 1991, pp. 292-325.
- Köhler, D; Reichel, T.: Power Meter NRV for 400 pW to 500 mW. *News from Rohde & Schwarz No. 116* (1987), pp. 13-15.

References

- Küfner, B.: Level Meter URV35 – a precision instrument for service and design engineers. News from Rohde & Schwarz No. 135 (1991), pp. 32-33.
- Kuhn, N.J.: Simplified Signal Flow Graph Analysis. Microwave Journal, Vol.6, No. 11 (Nov. 1963), pp. 59-66.
- Lamy, J.C.: Microelectronics Enhance Thermocouple Power Measurements. Hewlett-Packard Journal, Vol. 26, No. 1 (1974), pp. 19-24.
- Löser, A.: Power Reflection Meter NAP for SWR measurements. News from Rohde & Schwarz No. 106 (1984), pp. 9-11.
- Löser, A.: New thermocouple Power Sensors NRV-Z51 and NRV-Z52 based on semiconductor technology. News from Rohde & Schwarz No. 139 (1992), p. 34.
- McAllister, P.: Error Reduction in RF and Microwave Measurement. Microwave Journal, Oct. 1985, pp. 131-138.
- Microwave Powermate. A collection of useful information for microwave and RF engineers making power measurements. Marconi Instruments Ltd, 1989.
- Minck, J.: Understanding Measurement of RF and Microwave Pulsed Power. Microwave Journal, Nov. 1991, pp. 141-147.
- Mouw, R.B.; Coale, F.S.: Low Insertion Loss Directional Detector. United States Patent 3,611,123. Oct. 1971.
- Moyer, R.D.: Techniques for Measuring the Effective Source Reflection Coefficient of Two-Resistor Power Splitters. IEEE Transactions on Instrumentation and Measurement, Vol. IM-36, No. 1 (March 1987), pp. 23-28.
- Nak, S.C.; Shin, J.; Bayer, H.; Honigbaum, R.: Coaxial and Waveguide Microcalorimeters for RF and Microwave Power Standards. IEEE Transactions on Instrumentation and Measurement, Vol. 38, No. 2 (Apr. 1989), pp. 460-464.
- Nestler, W.: URE 2/3 for voltage measurements from millihertz to megahertz. News from Rohde & Schwarz No. 131 (1990), pp. 20-21.
- Power Monitoring. Handbook of Microwave Measurements, Vol. I. Polytechnic Press, 1963, pp. 156 ff.
- Radio Equipment and Systems (RES); Uncertainties in the measurement of mobile radio equipment characteristics. ETSI Technical Report ETRO28, June 1997, 3rd Edition, European Telecommunications Standards Institute. Valbonne, France.
- Reichel, T.: Peak Power Sensors NRV-Z, NAS-Z, NAP-Z. PEP measurements on TDMA radios, TV transmitters and lots more. News from Rohde & Schwarz No. 145 (1994), pp. 14-17.
- Reichel, T.: NRVD and NRVS, new thermocouple power meters. News from Rohde & Schwarz No. 137 (1992), pp. 4-7.
- Reichel, T.: Schaltung zum Messen einer von dem quadratischen Mittelwert einer Wechselspannung abgeleiteten Meßgröße, insbesondere des Effektivwerts einer Wechselspannung. German Patent DE 39 28 083 C2, Oct. 92.
- Reichel, T.: Hochpaßfilterschaltung. German Patent DE 40 00 131 C1, Apr. 91.
- Reichel, T.: RMS/Peak Voltmeter URE3: peak measurements without tilt or overshoot. News from Rohde & Schwarz No. 133 (1991), p. 38.
- Reichel, T.: Powerful and versatile – Directional Coupler URV5-Z9 for URV5 and NRV. News from Rohde & Schwarz No. 130 (1990), pp. 35-36.
- Reichel, T.: Shortwave power heads for Power Reflection Meter NAP. News from Rohde & Schwarz No. 117 (1987), pp. 39-40.
- Reichel, T.; Betz, T.; Köhler, D.; Schermer, J.: Einrichtung zum Messen von physikalischen Größen. German Patent Specification DE 31 16 690 C2, Sept. 83.
- Rhodes, C.W.: Measuring Peak and Average Power of Digitally Modulated Advanced Television Systems. IEEE Transactions on Broadcasting, Vol. 38, No. 4, (Dec. 1992), pp. 197-200.
- Rumfelt, A.Y.; Elwell, L.B.: Radio Frequency Power Measurements. Proc. of the IEEE, Vol. 55, No. 6 (June 1967), pp. 837-850.
- Scherer D. et al.: The Peak Power Analyzer, a New Microwave Tool. Hewlett-Packard Journal, April 1992, pp. 81-89.
- Szente, P.A.; Adam, S.; Riley, R.B.: Low-Barrier Schottky-Diode Detectors. Microwave Journal, Vol. 19, No. 2 (Feb. 1976).
- Szente, P.A.; Riley, R.B.: Wide Dynamic Range Radio-Frequency Power Sensor. United States Patent 4,943,764. July 1990.
- Weinert, F.K. and Weinschel, B.O.: Peak Power Measurement Independent of Detector Characteristics by Comparison of Video Samples. IEEE Transactions on Instrumentation and Measurement, Vol. IM-21, No. 4 (Nov. 1972), pp. 474-479.
- Wetenkamp, S.: Comparing single-diode and balanced power detectors. Microwaves & RF, Aug. 1983, pp. 120-122.
- Yasumura, G.; Genin, R.D.; Wetenkamp, S.F.: Broad Band Microwave Detector. United States Patent 4,360,865. Nov. 1982.

Fax Reply (Voltage and Power Measurements)

- Please send me an offer
- I would like a demo
- Please call me
- I would like to receive your free-of-charge CD-ROM catalogs

Others: _____

Name: _____

Company/Department: _____

Position: _____

Address: _____

Country: _____

Telephone: _____

Fax: _____

E-mail: _____



ROHDE & SCHWARZ