

R&S®FSVR Real-Time Spectrum Analyzer Discover the unseen



R&S®FSVR Real-Time Spectrum Analyzer

At a glance

The R&S®FSVR combines a full-featured signal and spectrum analyzer with a real-time spectrum analyzer. Therefore, it provides all the capabilities and features that modern T&M instruments of this kind have to offer. In real-time operation, the R&S®FSVR seamlessly measures and displays the spectrum in the time domain with a span of up to 40 MHz. As a result, it captures every event for analysis, no matter how brief that event might be.

Interference caused by sporadic and brief events in the frequency domain, by the spectral behavior of signal sources during frequency switching or by the influence of digital circuits on RF signals present a problem familiar to all development engineers and service technicians who work in the field of RF engineering. Pinpointing the cause of such problems is usually a difficult and time-consuming chore. In such situations, the R&S®FSVR's unique capabilities for capturing and displaying RF spectra in real-time help to analyze faults and characterize signals quickly and easily. It seamlessly measures the signal spectrum in real-time, and even with a time overlap. For visual evaluation, it offers a spectrogram in addition to the instantaneous spectrum in real-time; in persistence mode, it visualizes the real-time spectrum with color coding that indicates how often a signal occurs. Frequency-dependent masks provide support when triggering on spectral events. This makes it possible to reliably detect signals that occur sporadically in the spectrum and to investigate them effectively.

Besides its real-time capabilities, the R&S®FSVR offers all functions of the R&S®FSV signal and spectrum analyzer.

Key facts

- Frequency range from 10 Hz to 7/13.6/30/40 GHz
- 40 MHz real-time analysis bandwidth for:
 - Spectrum with persistence function
 - Spectrogram display
 - Display of power versus time
- Triggering on frequency masks
- Full-featured signal and spectrum analyzer with analysis software for GSM/EDGE, WCDMA/HSPA+, LTE, WiMAX™, WLAN, analog and digital modulation methods, noise figure and phase noise measurements
- Exchangeable hard disk for applications that involve the use of confidential data



R&S®FSVR Real-Time Spectrum Analyzer

Benefits and key features

Real-time spectrum analysis up to 40 GHz

- ▮ Spectrogram function for gapless spectrum display in the time domain
- ▮ Frequency mask trigger (FMT) for triggering the measurement on individual, sporadic events in the spectrum
- ▮ Persistence mode for visualizing how frequently signals occur
- ▮ Power versus time for analyzing the length/time variance of signals
- ▮ Real-time streaming of I/Q data for recording long RF sequences

▷ [page 4](#)

Full-featured signal and spectrum analyzer

- ▮ Frequency sweep across the entire frequency range from 10 Hz to 40 GHz in just a few milliseconds
- ▮ Expansion of the maximum input frequency to 110 GHz using external mixers
- ▮ Outstanding level measurement accuracy up to 7 GHz
- ▮ Excellent dynamic range and low phase noise
- ▮ High measurement speed
- ▮ Power measurement functions and statistical evaluations for analyzing digitally modulated signals
- ▮ Versatile marker and trace evaluation functions
- ▮ Measurement software for determining noise figure or phase noise
- ▮ General vector signal analysis (VSA) and special analysis options for GSM/EDGE, WCDMA/HSPA+, LTE, WiMAX™, WLAN as well as analog modulation methods
- ▮ Large I/Q memory depth

▷ [page 11](#)

Simple and intuitive touchscreen operation

- ▮ Touchscreen operation: using a finger as a mouse cursor
- ▮ Fast access to all important functions
- ▮ Built-in help function
- ▮ Undo/redo function

▷ [page 14](#)

Low total cost of ownership

- ▮ Convenient on-site retrofitting of options
- ▮ Easy scalability to handle application-specific requirements
- ▮ Always up-to-date with firmware updates

▷ [page 15](#)

Real-time spectrum analysis up to 40 GHz

In real-time mode, the R&S®FSVR measures the signal spectrum with a bandwidth of up to 40 MHz around the set center frequency. The data for calculating and displaying the spectrum is recorded without gaps. In order to provide spectrum measurements that are true to the original, especially in the case of pulsed signals, the R&S®FSVR overlaps the data segments for transformation into the frequency domain by at least 80%. The instrument reliably captures even extremely short-term signals and pulsed signals, because it processes the sampled time signal without interruption. This real-time functionality is available at input frequencies up to 40 GHz and, with external mixers, even up to 110 GHz – which makes the R&S®FSVR unique.

The figure below shows the R&S®FSVR's signal processing chain in real-time mode. The analyzer samples the intermediate frequency signal at 128 MHz and transforms it into the frequency domain after windowing in the time domain. In the process, the R&S®FSVR calculates up to 250 000 spectra per second. For display on the screen, it combines the individual spectra in the detector. Since the human eye is not able to process such a large number of spectra, the instrument limits the trace's update rate on the screen to 30 images per second.

Key specifications for real-time mode	
Real-time RF bandwidth	100 Hz to 40 MHz
A/D converter	128 Msample/s, 16 bit
Windowing	Blackman Harris, Gauss, flat top, rectangular, Hanning, Kaiser
Measurement points per trace	801
Resolution bandwidth	real-time RF bandwidth/(100 to 400), depending on windowing
Number of spectra per second	up to 250 000/s
Screen update rate	30/s
Minimum event time that can be registered (for correct display of power)	24 µs
Detectors	Average (linear or RMS), Max Peak, Min Peak, Sample
Trace functions	Max Hold, Min Hold, Average, Clear/Write
Minimum detectable signal duration	25 ns (nom.)

For fast Fourier transformation, the R&S®FSVR uses 1000 discrete points and therefore automatically adapts the resolution bandwidth to the desired real-time RF bandwidth:

Real-time RF bandwidth	Resolution bandwidth (Blackman Harris)
40 MHz	200 kHz
10 MHz	50 kHz
1 MHz	5 kHz
100 kHz	500 Hz

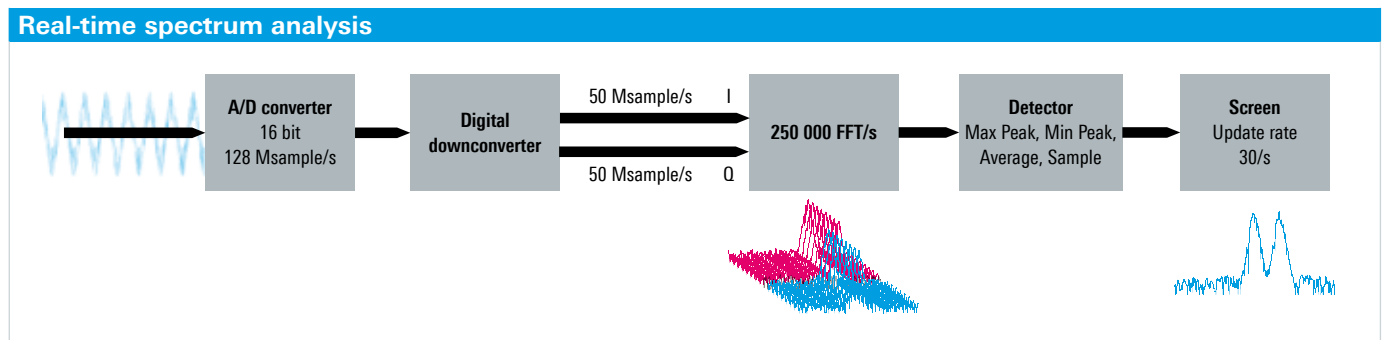

Spectrogram function for gapless spectrum display in the time domain

The spectrogram function allows the R&S®FSVR to display the spectrum seamlessly versus time. Here, the instrument assigns a color to the signal level so that a horizontal line is sufficient to display the spectrum. Generating a continuous sequence of lines (spectrogram) creates a complete picture of the spectrum versus time.

When displaying the spectrogram, the R&S®FSVR can store up to 100 000 traces. As a result, it is able to record for up to five hours, depending on the update rate that is set.

Key specifications for the spectrogram function	
Spectrogram memory depth	100 000 traces
Spectrogram update rate (real-time)	1/s to 10 000/s
Detectors	Average (linear or RMS), Max Peak, Min Peak, Sample
Recording period	up to 5 h

Markers in the spectrogram help to ensure precise measurement of events that occur within the signal spectrum, including, for instance, their time intervals and durations as well as the frequencies at which they occur. As a result, users can conveniently monitor the frequency bands without gaps. This is advantageous not only for monitoring a frequency spectrum, but also for tracking down sporadic interference, which can cause significant problems for a useful RF signal. For wireless transmissions in which the frequency changes often, such as RFID or Bluetooth®

applications, the R&S®FSVR is a useful tool for observing frequency hops and for characterizing transmitters. The information collected in this way can then be used for a frequency-selective trigger in order to record and analyze exactly the data set that exists for a specific frequency hop or interference signal. This makes troubleshooting of transmitters considerably faster and easier.

A variety of display options make work with the R&S®FSVR very easy. For instance, the instrument offers both pre-defined and user-defined color scales for specific measurement tasks.



Spectrum and spectrogram of GSM signals on different frequency bands. Markers are used to measure a frame length of 4.6 ms.

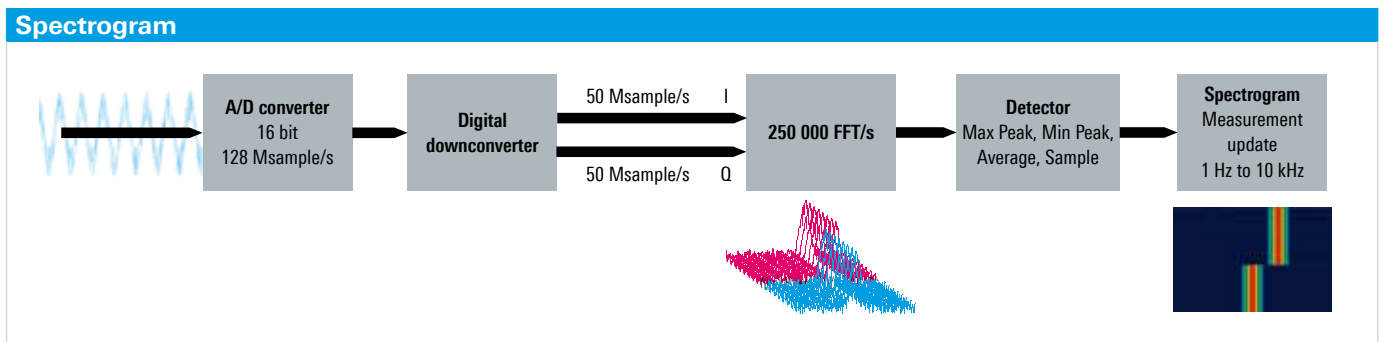

Frequency mask trigger (FMT) for triggering the measurement on individual, sporadic events in the spectrum

The FMT responds to events in the spectrum; the figure below shows the processing chain. The R&S®FSVR evaluates each individual spectrum in real-time mode so that no information is lost. If a spectrum violates the predefined mask, the R&S®FSVR triggers a response and stops the measurement either immediately or after a selectable follow-up period. The data collected in response to the trigger event remains available for detailed analysis.

As a result, the R&S®FSVR can analyze the influence of interference signals on transmitters very quickly. The same holds true for signals directly following a frequency hop.

With just a press of a finger, users are able to define the mask for the FMT by making selections directly on the touchscreen. Clearly structured tables and diagrams help users to change the mask quickly and adapt it to new situations, or the instrument can generate the mask automatically. The figure on the next page shows the simple and straightforward user interface for operating the frequency mask trigger. In addition to an upper limit line, the user can also define a lower limit. Combining both trigger conditions enables triggering in situations when a spectrum departs from predefined level ranges (for example, when a certain power level is exceeded or not reached although the power level remains constant on average). The FMT can be used with all display options such as spectrum (with or without persistence) or spectrogram.

Key FMT specifications	
Frequency resolution	real-time bandwidth/801
Trigger span	up to real-time RF bandwidth
Dynamic range	0 dB to -80 dB below the reference level
Trigger inaccuracy	$\pm 12.5 \mu\text{s}$ at 40 MHz real-time bandwidth
Trigger conditions	<ul style="list-style-type: none"> ■ within the mask ■ outside the mask ■ mask entry ■ mask exit
Max. number of mask points	801 points
Additional trigger sources	external, periodic trigger, IF level, RF level, free run

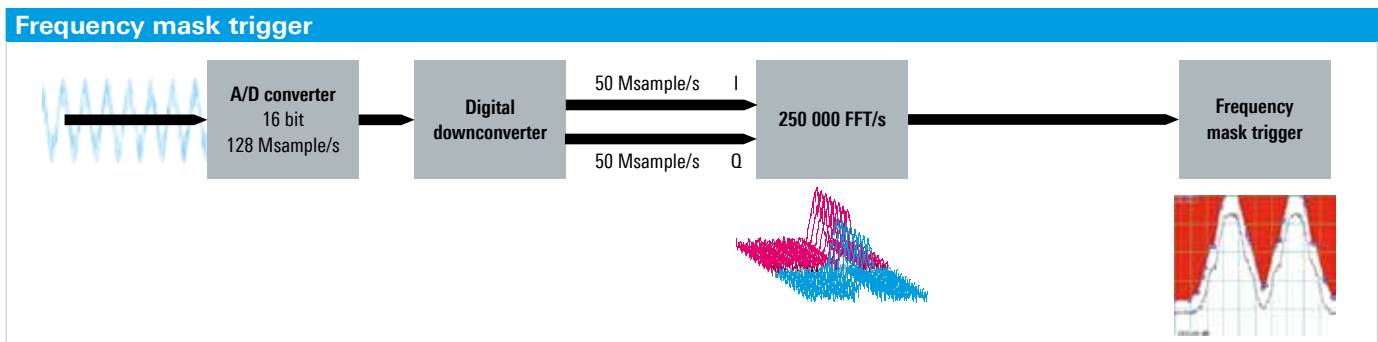

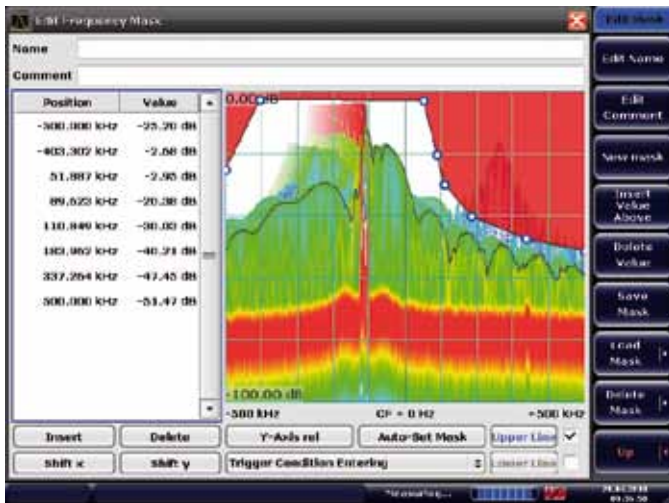

Input window for the limit lines of the frequency-selective trigger. The R&S®FSVR displays the current trace. The individual points for the limit line can either be entered using the numeric keys or on-screen keys, or they can be moved to the desired position directly on the screen.

Various measurement applications, such as general vector signal analysis, offer the FMT as a trigger option. This option allows users to analyze the signal in detail when the signal quality is compromised by an interferer, for example.

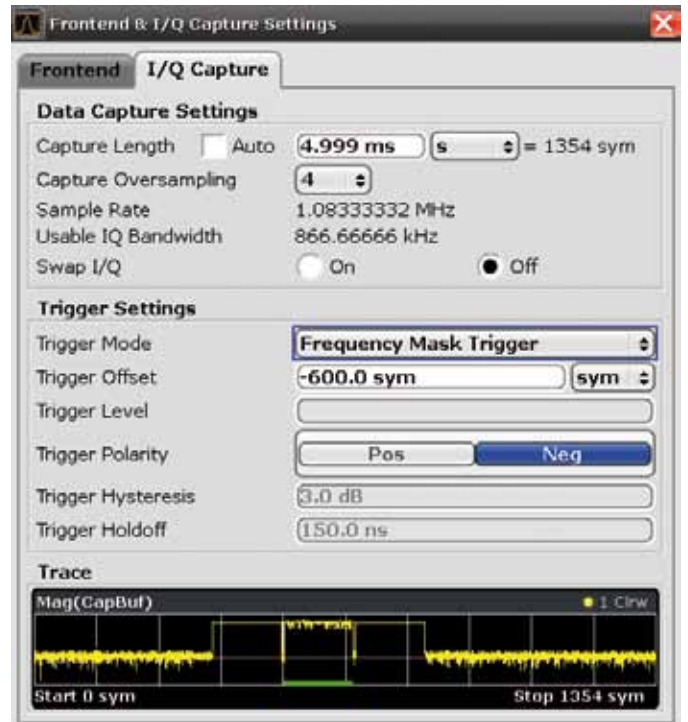

Definition window for I/Q data capturing in the R&S®FSV-K70 option (general vector signal analysis): The FMT trigger mode is available in addition to the standard trigger modes.

Persistence mode for visualizing how frequently signals occur

In order to gain an impression of spectrum variation over time, the R&S®FSVR seamlessly superimposes all spectra in a diagram. The color of the traces shows how often a signal occurs at a specific frequency and level. If signals no longer occur at a frequency with a certain amplitude, the trace disappears after a user-definable persistence period.

The persistence mode creates a spectral histogram and is a valuable aid for examining signals that change over time. The R&S®FSVR can use this function, for example, to analyze the fast transient response behavior of synthesizers. Gapless visualization of all frequencies and amplitudes that occur, including probability weighting, conveys a completely new impression of the system's dynamic behavior in the spectral range. Users can see if fast frequency hops occur or if the amplitude changes significantly for brief periods of time. Effects like these can strongly influence the behavior of the entire system but are difficult to detect with conventional analyzers.

The figure below shows the signal processing chain for the persistence mode. The R&S®FSVR evaluates all spectra for this mode. The screenshot shows a typical measurement. The analyzer captures and displays even very short signals, providing a complete picture of the time variation of the frequencies and amplitudes occurring in the frequency domain.

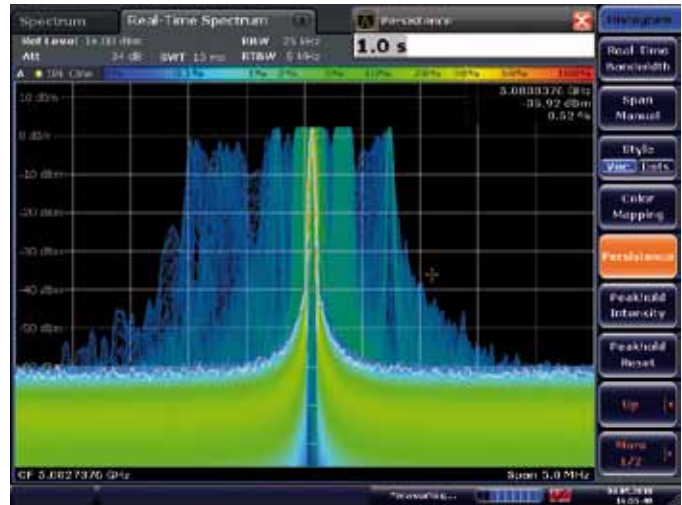

Transient response of a VCO for WLAN applications in persistence mode.

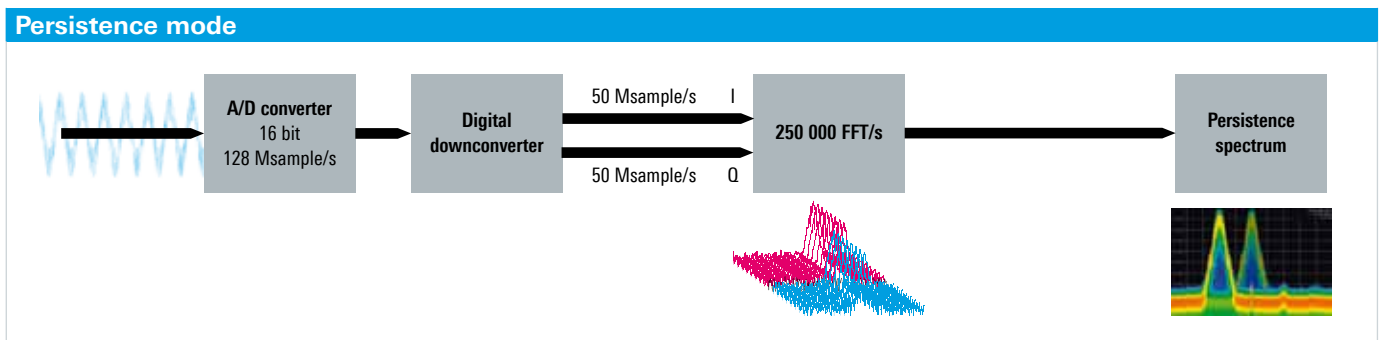

Power versus time for analyzing the length/time variance of signals

The power versus time function provides an overview of signals in the time domain. The R&S®FSVR generates a real-time display of the signal's power versus time. When the end of the set time window is reached, the signal is displayed again from the beginning of the window without losing any timeslots. A time domain or frequency mask trigger can be used to trigger on specific events and obtain a stable image.

This function allows users to easily determine the length of pulses without having to switch to the spectrum analysis mode. It can also be used to determine the length of sporadic interferers that were captured using the FMT, for example. This makes it easy to analyze the frequency, amplitude and length of sporadic, difficult-to-detect signals.

A waterfall diagram of the time domain display opens up even more applications. The waterfall diagram can be used to monitor the behavior of time signals versus time. An example of a typical application is measuring pulse-to-pulse jitter. The user triggers on a pulse and monitors the constancy of the pulse interval; real-time data processing prevents the loss of pulses – all outliers are captured.

Key specifications for power versus time	
Traces	4
Trace detectors	Max Peak, Min Peak, Sample, Average
Trace functions	Clear/Write, View
Markers	16
Number of sweeps per second	1250/s



The waterfall diagram (bottom right) of the time domain display (top right) shows the pulse-to-pulse jitter of an airport radar signal. The first pulse that activates the trigger is displayed as a vertical line so that the variation in the interval to the next pulse can be clearly identified. The spectrum and the spectrogram in the frequency domain are shown on the left.

Real-time streaming of I/Q data for recording long RF sequences

The R&S®FSV-B17 option adds digital inputs and outputs for baseband I/Q data to the R&S®FSVR. The R&S®FSVR uses these digital interfaces to supply a continuous, gapless I/Q data stream with a bandwidth of up to 40 MHz. Real-world RF scenarios can be recorded and replayed, for instance using a Rohde&Schwarz signal generator.

When the R&S®FSVR's digital interfaces are connected with an R&S®SMU or R&S®SMATE vector signal generator, the I/Q data from the generator can again be modulated directly onto a carrier and transmitted. The generator can add noise to the signal beforehand or apply fading scenarios, which makes this combination of instruments a true RF fader.

The R&S®EX-IQ-BOX converts the digital baseband signals from the Rohde&Schwarz measuring instruments into the standardized digital formats used in modern communications technology, and vice versa. As a result, combining the R&S®EX-IQ-BOX and the R&S®FSVR with the R&S®FSV-B17 option also makes it possible to analyze these digital baseband signals, as they are used, for example, in modern base stations.

This option is primarily of interest to the following users:

- Users who work with digital baseband interfaces for mobile communications applications, such as CPRI, OBSAI and DigRF 4G
- Users who need a versatile RF fader
- Users who want to record and replay long RF sequences (for example, to simulate real-world conditions in a lab setting, e.g in combination with the R&S®IQR I/Q data recorder and vector signal generators from Rohde&Schwarz)

Real-time streaming

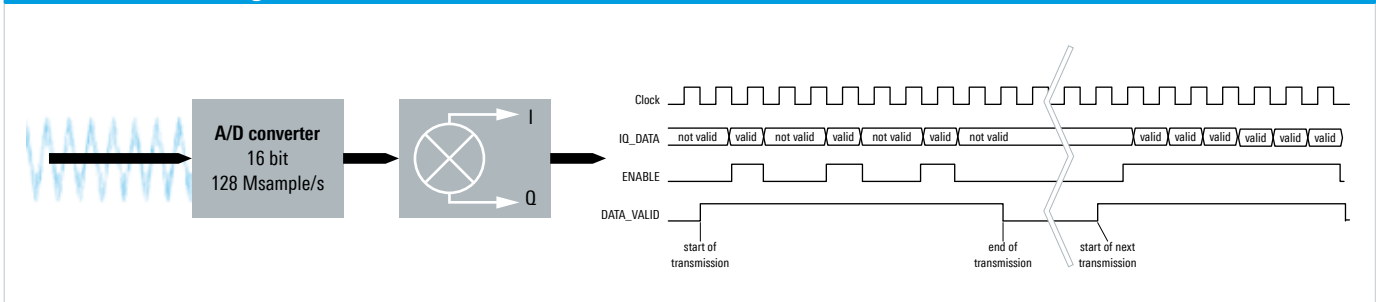

Full-featured signal and spectrum analyzer

Frequency sweep across the entire frequency range from 10 Hz to 40 GHz in just a few milliseconds

The R&S®FSVR is based on the R&S®FSV – a fast, full-featured signal and spectrum analyzer with excellent RF characteristics and all the functions that advanced analyzers offer (for detailed information, see the R&S®FSV product brochure). The R&S®FSV and the R&S®FSVR are among the fastest and most versatile signal and spectrum analyzers for developing, manufacturing, installing and servicing RF instruments and systems.

For development environments, the signal and spectrum analyzer contained in the R&S®FSVR provides excellent RF characteristics, an analysis bandwidth of 40 MHz that is unique in this class, and a wide range of test and measurement applications for analog and digital modulation methods, as well as for mobile radio and wireless transmission standards. A large variety of test and measurement functions – such as adjacent channel power measurement (ACPR or ACLR), spectrum emission masks (SEM), third-order intercept (TOI), complementary cumulative distribution function (CCDF) and spurious emission measurements – are included in the base unit.

The R&S®FSVR is five times faster than comparable signal analyzers, and it features time-optimized measurement routines and high data throughput. This provides a crucial advantage in production applications.

Expansion of the maximum input frequency to 110 GHz using external mixers

Equipped with the R&S®FSV-B21 option, the R&S®FSVR supports external harmonic mixers and expands the frequency range up to 110 GHz or – with external harmonic mixers from third-party vendors – even beyond that. Such a frequency range is nothing new in spectrum analysis, but when it comes to real-time operation, this input frequency range makes the R&S®FSVR unique on the market.

Outstanding level measurement accuracy up to 7 GHz

Featuring a total measurement uncertainty of just 0.4 dB up to 7 GHz, the R&S®FSVR is, like the R&S®FSV, a leader in its class and provides accurate, reliable measurement results. The R&S®FSVR can also perform high-precision measurements in the 5.8 GHz ISM band, which makes additional power meters unnecessary in many cases.

Equipped with the R&S®FSV-K9 option, the R&S®FSVR supports the direct connection of the power sensors from the R&S®NRP series. This boosts the accuracy of power measurements with particularly stringent requirements and eliminates the need for an external power meter. The R&S®NRP-Z27 and R&S®NRP-Z37 sensors contain an integrated power splitter so that the power sensor and the R&S®FSVR can measure the same signal in parallel without switching.

External mixers from Rohde & Schwarz extend the accessible frequency range to up to 110 GHz.



Excellent dynamic range and low phase noise

The R&S®FSVR features superior RF characteristics:

- ▮ Displayed average noise level (DANL)
 - -155 dBm (1 Hz) at 1 GHz
 - -145 dBm (1 Hz) at 30 GHz
- ▮ DANL with preamplifier
 - -163 dBm (1 Hz) at 1 GHz
 - -162 dBm (1 Hz) at 30 GHz
- ▮ DANL at 9 kHz only -140 dBm (1 Hz)
- ▮ Third-order intercept: 16 dBm (f < 3.6 GHz)
- ▮ Phase noise at 10 kHz offset from the carrier:
 - < -106 dBc (1 Hz), typ. -110 dBc (1 Hz)
- ▮ Dynamic range for WCDMA ACLR: 73 dB
- ▮ Resolution bandwidths
 - 1 Hz to 10 MHz
 - 20 MHz/40 MHz in zero span

High measurement speed

With more than 1000 sweeps/s, the R&S®FSVR in spectrum analysis mode is up to five times faster than all other spectrum analyzers in this class. This high measurement speed not only accelerates production, it also shortens measurement times when – as stipulated by many standards – a large number of measurements must be averaged.

Additional R&S®FSVR functions accelerate measurements, shorten alignment and measurement times and increase throughput:

- ▮ Broadband RF power detector – acceleration of AUTORANGE
- ▮ Frequency list mode (LIST MODE) – fast measurement on up to 300 different frequencies with different analyzer settings by means of one remote control command
- ▮ Measurement of different power levels in the time domain in one sweep in order to make alignment of transmitters in production many times faster
- ▮ Fast ACP measurement in the time domain with channel filters
- ▮ Frequency counter with 1 Hz resolution at a measurement time of < 50 ms
- ▮ Gbit LAN interface for fast transmission of large amounts of data
- ▮ Trigger interface for synchronization with the production system in LIST MODE
- ▮ Four USB 2.0 ports (two at front, two at rear)

Power measurement functions and statistical evaluations for analyzing digitally modulated signals

- ▮ Channel/adjacent channel power measurements
 - Up to 12 user channels, up to 12 adjacent channels
 - Many predefined settings for standard-compliant measurements
- ▮ Occupied bandwidth (OBW)
- ▮ Spectrum emission mask (SEM) measurement
- ▮ Complementary cumulative distribution function (CCDF, power statistics)
- ▮ Burst power measurement
- ▮ Spurious emissions
- ▮ C/N and C/N₀ signal-to-noise ratio
- ▮ Complete selection of detectors: RMS, Average, Auto Peak, Pos/Neg Peak, Sample, Quasi Peak



SEM measurement of a signal from a 3GPP base station.

Versatile marker and trace evaluation functions

- Up to 16 markers
- Marker measurement functions, such as AM modulation factor, TOI, phase noise/noise, frequency counter
- Up to six simultaneously active traces with any combination of detectors
- Selectable number of sweep points (up to 32 001)
- Peak list for evaluating up to 100 peaks at the press of a key
- Limit lines for PASS/FAIL monitoring
- Transducer factors

Measurement software for determining noise figure or phase noise

Besides the standard functions, the R&S®FSVR also offers special options for measuring phase noise or noise figure:

- The R&S®FSV-K30 noise figure and gain measurements option measures the noise figure and gain of linear or frequency-converting components at the press of a key using an external noise source
- The R&S®FSV-K40 phase noise measurement software measures the phase noise of signal sources. A logarithmic display over the frequency shows the offset range of interest. Residual FM/φM and jitter are also evaluated

General vector signal analysis (VSA) and special analysis options for GSM/EDGE, WCDMA/HSPA+, LTE, WiMAX™, WLAN as well as analog modulation methods

Besides the classic fields of applications for spectrum analyzers, the R&S®FSVR also covers the analysis of digital transmission methods from advanced communications standards by using special software measurement applications. To increase data rates and transmission capacity, mobile radio and wireless transmission systems are using ever larger RF bandwidths. Due to its broad analysis bandwidth and extensive range of software options, the R&S®FSVR covers all current as well as future mobile radio applications. Currently, the following standards are supported:

- GSM/EDGE/EDGE Evo
- WCDMA
- TD-SCDMA
- CDMA2000®
- WLAN 802.11 a/b/g/n
- WiMAX™
- LTE (TDD/FDD)

In addition, the following capabilities are available:

- General vector signal analysis (VSA)
- AM/FM/φM demodulator
- FM stereo measurement application

Large I/Q memory depth

The R&S®FSVR has a standard I/Q memory depth of 200 Msample. This makes it possible to record the data over long periods, even at high bandwidths and high sampling rates. Conventional spectrum analyzers offer an I/Q memory depth of just a few Msample.



General vector signal analysis for determining the modulation quality of digitally modulated signals (16QAM).

Simple and intuitive touchscreen operation

The R&S®FSVR is very easy to operate. The touchscreen, on-screen keys and hotkeys provide a groundbreaking operating concept for advanced test and measurement equipment. In addition, the straightforward, intuitive menus considerably reduce the amount of time needed to become familiar with the instrument.

Touchscreen operation: using a finger as a mouse cursor

The R&S®FSVR can be operated particularly quickly and conveniently by just touching the screen.

As an alternative, all functions and measurement parameters can also be set using keys and the rotary knob or a mouse and keyboard. The large SVGA display's high resolution provides excellent readability.

Fast access to all important functions

Labeled keys provide fast access to the most important menu items, settings and functions. Parameters such as frequency and bandwidth can be set directly. Hardkeys for functions that are required frequently, such as Preset and Save/Recall, also make operation easier.

Built-in help function

The context-sensitive help with a detailed explanation of the current function and specification of the corresponding remote control commands also supports beginners and infrequent users. It simplifies programming and eliminates the need for manuals.

Undo/redo function

Up to six previous operating steps can be revoked. This makes it easy to correct operating errors or to switch quickly between two different states.

The touchscreen enables fast and easy operation. However, the instrument also offers conventional control elements.

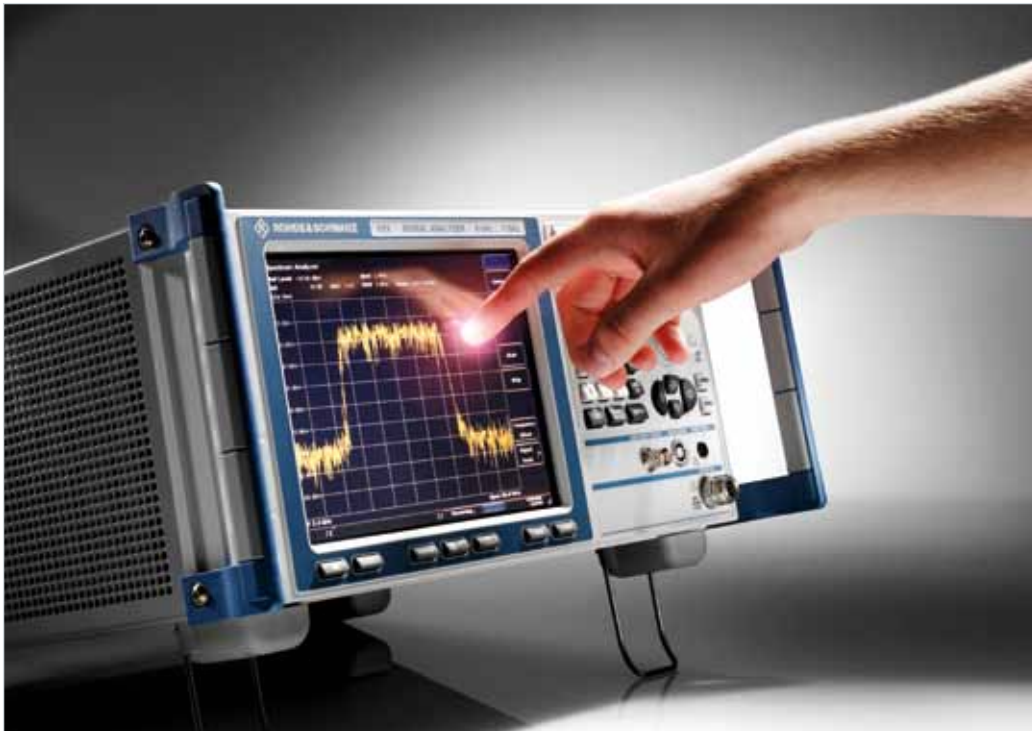

Low total cost of ownership

Convenient on-site retrofitting of options

The plug & play concept enables users to easily install hardware options on-site. In most cases, it is not even necessary to open the R&S®FSVR to do so.

The advantages are obvious:

- No additional alignment after installation
- No recalibration
- No need to send in the instrument, which means no downtime
- No installation costs
- Easy expandability for additional tasks

Easy scalability to handle application-specific requirements

The base unit is already equipped with all of the functions that are expected of a real-time spectrum analyzer. Numerous options are available for tailoring the R&S®FSVR to a variety of applications.

Always up-to-date with firmware updates

The R&S®FSVR's firmware is updated easily using a USB memory stick or the LAN interface. Firmware updates can be downloaded from the Rohde&Schwarz website at no charge.

Users can retrofit hardware options simply by using the plug&play interfaces on the rear of the instrument.



Specifications in brief

Specifications in brief		
Frequency		
Frequency range	R&S®FSVR7	10 Hz to 7 GHz
	R&S®FSVR13	10 Hz to 13.6 GHz
	R&S®FSVR30	10 Hz to 30 GHz
	R&S®FSVR40	10 Hz to 40 GHz
Aging of frequency reference		1×10^{-6}
	with R&S®FSV-B4 option	1×10^{-7}
Real-time spectrum analyzer		
Real-time RF bandwidth		100 Hz to 40 MHz
A/D converter		128 Msample/s, 16 bit
Windowing		Blackman Harris, Gauss, flat top, rectangular, Hanning, Kaiser
Measurement points per trace		801
Resolution bandwidth		real-time RF bandwidth/(100 to 400), depending on windowing
Number of spectra per second		250 000/s
Spectrogram update rate		10 000/s
Screen update rate		30/s
Detectors		Average (linear or RMS), Max Peak, Min Peak, Sample
Trace functions		Max Hold, Min Hold, Average
FMT		
Frequency resolution		real-time bandwidth/801
Trigger span		real-time RF bandwidth
Dynamic range		0 dB to -80 dB below reference level
Spectrum analyzer		
Bandwidths		
Resolution bandwidths	standard filter	1 Hz to 10 MHz
	standard filter, ZERO SPAN	1 Hz to 10 MHz, 20 MHz, 40 MHz
	FFT sweep	1 Hz to 300 kHz
	channel filter	100 Hz to 5 MHz
Video filter		1 Hz to 10 MHz, 20 MHz, 28 MHz, 40 MHz
I/Q demodulation bandwidth		40 MHz
Displayed average noise level		
Displayed average noise level	1 GHz	-152 dBm (1 Hz)
	30 GHz	-150 dBm
Displayed average noise level with preamplifier, R&S®FSV-B22 or R&S®FSV-B24 option	1 GHz	-163 dBm
	30 GHz	-162 dBm
Intermodulation		
TOI	$f < 3.6$ GHz	16 dBm
Dynamic range		
WCDMA ACLR	without noise compensation	70 dB
	with noise compensation	73 dB
Phase noise		
1 GHz carrier frequency	10 kHz offset from carrier	-106 dBc (1 Hz)
	100 kHz offset from carrier	-115 dBc (1 Hz)
	1 MHz offset from carrier	-134 dBc (1 Hz)
Total measurement uncertainty	$f < 7$ GHz	0.4 dB

Ordering information

Designation	Type	Order No.
Base unit (including supplied accessories such as power cable and manual)		
Real-Time Spectrum Analyzer, 10 Hz to 7 GHz	R&S®FSVR7	1311.0006.07
Real-Time Spectrum Analyzer, 10 Hz to 13.6 GHz	R&S®FSVR13	1311.0006.13
Real-Time Spectrum Analyzer, 10 Hz to 30 GHz	R&S®FSVR30	1311.0006.30
Real-Time Spectrum Analyzer, 10 Hz to 40 GHz	R&S®FSVR40	1311.0006.40
Hardware options		
AM/FM Audio Demodulator	R&S®FSV-B3	1310.9516.02
OCXO, Precision Reference Frequency	R&S®FSV-B4	1310.9522.02
OCXO, Improved Frequency Stability	R&S®FSV-B4	1310.9522.03
Additional Interfaces (IF/video/AM/FM output, AUX port, trigger output, two additional USB ports)	R&S®FSV-B5	1310.9539.02
Digital Baseband Interface	R&S®FSV-B17	1310.9568.02
Solid-State Drive (removable hard drive)	R&S®FSVR-B18	1310.9697.04
Spare Hard Drive (removable hard drive)	R&S®FSVR-B19	1310.9574.04
LO/IF Ports for External Mixers	R&S®FSV-B21	1310.9597.02
RF Preamplifier, 9 kHz to 7 GHz	R&S®FSV-B22	1310.9600.02
RF Preamplifier, 9 kHz to 13.6 GHz	R&S®FSV-B24	1310.9616.13
RF Preamplifier, 9 kHz to 30 GHz	R&S®FSV-B24	1310.9616.30
RF Preamplifier, 9 kHz to 40 GHz	R&S®FSV-B24	1310.9616.40
Electronic Attenuator (1 dB steps)	R&S®FSV-B25	1310.9622.02
Software options		
Stereo Measurements	R&S®FSV-K7S	1310.8126.02
Bluetooth®/EDR	R&S®FSV-K8	1310.8155.02
Power Sensor Support (power measurement with the R&S®NRP power sensors)	R&S®FSV-K9	1310.8203.02
GSM/EDGE/EDGE Evolution Analysis	R&S®FSV-K10	1310.8055.02
Noise Figure and Gain Measurements	R&S®FSV-K30	1310.8355.02
Phase Noise Measurements	R&S®FSV-K40	1310.8403.02
Vector Signal Analysis	R&S®FSV-K70	1310.8455.02
3GPP FDD BS Analysis, incl. HSPA+	R&S®FSV-K72	1310.8503.02
3GPP FDD UE Analysis, incl. HSPA+	R&S®FSV-K73	1310.8555.02
TD-SCDMA BTS Measurements	R&S®FSV-K76	1310.8603.02
TD-SCDMA UE Measurements	R&S®FSV-K77	1310.8655.02
CDMA2000® BS (DL) Analysis	R&S®FSV-K82	1310.8703.02
CDMA2000® MS Measurements	R&S®FSV-K83	1310.8755.02
1xEV-DO BS (DL) Analysis	R&S®FSV-K84	1310.8803.02
1xEV-DO MS Measurements	R&S®FSV-K85	1310.8778.02
WLAN IEEE 802.11a/b/g/j Analysis	R&S®FSV-K91	1310.8903.02
WLAN IEEE 802.11n Analysis	R&S®FSV-K91n	1310.9468.02
WiMAX™ IEEE 802.16 SISO Analysis	R&S®FSV-K93	1310.8955.02
EUTRA/LTE FDD Downlink Analysis	R&S®FSV-K100	1310.9051.02
EUTRA/LTE FDD Uplink Analysis	R&S®FSV-K101	1310.9100.02
EUTRA/LTE Downlink MIMO Measurements	R&S®FSV-K102	1310.9151.02
EUTRA/LTE TDD Downlink Analysis	R&S®FSV-K104	1309.9774.02
EUTRA/LTE TDD Uplink Analysis	R&S®FSV-K105	1309.9780.02
Analysis software		
OFDM Vector Signal Analysis	R&S®FSV-K96PC	1310.0202.06
Distortion Analysis Software	R&S®FSV-K130PC	1310.0090.06

Service options

Two-Year Calibration Service	R&S®CO2FSVR	Please contact your local Rohde & Schwarz sales office.
Three-Year Calibration Service	R&S®CO3FSVR	
Five-Year Calibration Service	R&S®CO5FSVR	
One-Year Repair Service following the warranty period	R&S®RO2FSVR	
Two-Year Repair Service following the warranty period	R&S®RO3FSVR	
Four-Year Repair Service following the warranty period	R&S®RO5FSVR	

For data sheet, see PD 5214.3381.22 and www.rohde-schwarz.com.

The Bluetooth® word mark and logos are registered trademarks owned by Bluetooth SIG, Inc. and any use of such marks by Rohde & Schwarz is under license.

CDMA2000® is a registered trademark of the Telecommunications Industry Association (TIA - USA).

"WiMAX Forum" is a registered trademark of the WiMAX Forum. "WiMAX," the WiMAX Forum logo, "WiMAX Forum Certified," and the WiMAX Forum Certified logo are trademarks of the WiMAX Forum.

Your local Rohde & Schwarz expert will help you determine the optimum solution for your requirements.

To find your nearest Rohde & Schwarz representative, visit

www.sales.rohde-schwarz.com

From pre-sale to service. At your doorstep.

The Rohde&Schwarz network in over 70 countries ensures optimum on-site support by highly qualified experts. The user risks are reduced to a minimum at all stages of the project:

- ▮ Solution finding/purchase
- ▮ Technical start-up/application development/integration
- ▮ Training
- ▮ Operation/calibration/repair



Service you can rely on

- | Worldwide
- | Local and personalized
- | Customized and flexible
- | Uncompromising quality
- | Long-term dependability

About Rohde & Schwarz

Rohde & Schwarz is an independent group of companies specializing in electronics. It is a leading supplier of solutions in the fields of test and measurement, broadcasting, radiomonitoring and radiolocation, as well as secure communications. Established more than 75 years ago, Rohde & Schwarz has a global presence and a dedicated service network in over 70 countries. Company headquarters are in Munich, Germany.

Environmental commitment

- | Energy-efficient products
- | Continuous improvement in environmental sustainability
- | ISO 14001-certified environmental management system

Certified Quality System
ISO 9001

Rohde & Schwarz GmbH & Co. KG

www.rohde-schwarz.com

Regional contact

- | Europe, Africa, Middle East
+49 89 4129 123 45
customersupport@rohde-schwarz.com
- | North America
1 888 TEST RSA (1 888 837 87 72)
customer.support@rsa.rohde-schwarz.com
- | Latin America
+1 410 910 79 88
customersupport.la@rohde-schwarz.com
- | Asia/Pacific
+65 65 13 04 88
customersupport.asia@rohde-schwarz.com

R&S® is a registered trademark of Rohde & Schwarz GmbH & Co. KG
Trade names are trademarks of the owners | Printed in Germany (ft)
PD 5214.3381.12 | Version 02.00 | November 2010 | R&S®FSVR
Data without tolerance limits is not binding | Subject to change
© 2010 Rohde & Schwarz GmbH & Co. KG | 81671 München, Germany



5214338112